

**ABBATTITORI/SURGELATORI DI TEMPERATURA
CELLULES DE REFROIDISSEMENT RAPIDE/CELLULES MIXTES
SCHNELLKÜHLER/SCHOCKFROSTER
BLAST CHILLERS/FREEZERS
ABATIDORES/CONGELADORES RAPIDOS DE TEMPERATURA
AFKOEL/VRIESKAST
ABATEDORES/CONGELADORES RÁPIDOS DA TEMPERATURA
БЫСТРЫЕ ОХЛАДИТЕЛИ/МОРОЗИЛЬНИКИ**

**MANUALE D'USO E INSTALLAZIONE
MANUEL D'UTILISATION ET D'INSTALLATION
BEDIEN- UND INSTALLATIONSHANDBUCH
USE AND INSTALLATION MANUAL
MANUAL DE USO E INSTALACIÓN
GEBRUIKS- EN INSTALLATIEHANDLEIDING
MANUAL DE USO E INSTALAÇÃO
РУКОВОДСТВО ПО ЭКСПЛУАТАЦИИ И УСТАНОВКЕ**



IT

Leggere attentamente le avvertenze contenute nel presente libretto in quanto forniscono importanti indicazioni riguardanti la sicurezza, d'uso e di manutenzione.

Conservare con cura questo libretto per ogni ulteriore consultazione dei vari operatori.

Il costruttore si riserva il diritto di apportare modifiche al presente manuale, senza preavviso e responsabilità alcuna.

FR

Lire avec attention les instructions contenues dans ce livret car elles fournissent d'importants renseignements pour ce qui concerne la sécurité, l'emploi et l'entretien.

Garder avec soin ce livret pour des consultations ultérieures de différents opérateurs.

Le constructeur se réserve le droit d'apporter des modifications à ce manuel, sans préavis ni responsabilité d'aucune sorte.

DE

Lesen Sie bitte aufmerksam diese Gebrauchsanweisung durch, die wichtige Informationen bezüglich der Sicherheit, dem Gebrauch und der Instandhaltung enthält.

Heben Sie sorgfältig diese Gebrauchsanweisung auf, damit verschiedene Anwender sie zu Rat ziehen können.

Der Hersteller behält sich das Recht, Änderungen dieser Gebrauchsanweisung ohne Ankündigung und ohne Übernahme der Verantwortung vornehmen zu können.

GB

Carefully read the instructions contained in the handbook. You may find important safety instructions and recommendations for use and maintenance.

Please retain the handbook for future reference.

The Manufacturer is not liable for any changes to this handbook, which may be altered without prior notice.

ES

Lea atentamente las advertencias contenidas en este manual pues dan importantes indicaciones concernientes la seguridad, la utilización y el mantenimiento del aparato.

Rogamos guarde el folleto de instalación y utilización, para eventuales futuros usuarios.

El constructor se reserva el derecho de hacer modificaciones al actual manual, sin dar algún preaviso y sin responsabilidad alguna.

NL

Nauwkeurig de waarschuwingen in dit boekje lezen, aangezien zij belangrijke aanwijzingen verschaffen wat betreft de veiligheid, het gebruik en het onderhoud.

Dit boekje goed bewaren.

De fabrikant behoudt zich het recht voor om veranderingen in deze handleiding aan te brengen, zonder voorafgaande waarschuwing en zonder enkele aansprakelijkheid.

P

Leia com atenção as advertências contidas neste manual pois fornecem importantes indicações para a segurança, a utilização e a manutenção do aparelho.

O construtor reserva-se o direito de modificar o manual sem dar aviso prévio e sem nenhuma responsabilidade.

RU

Внимательно читайте предупреждения, содержащиеся в настоящем руководстве, касающиеся надежности использования и обслуживания.

Конструктор сохраняет за собой право вносить изменения в настоящее руководство без предупреждения и любой ответственности.

INDEX

GENERAL INSTRUCTIONS ON DELIVERY.....	5
GENERAL WARNINGS	5
LIST OF REGULATION REFERENCES.....	5
TRANSPORTATION AND HANDLING	5
UNPACKING	5
GENERAL SAFETY WARNINGS	6
INSTALLATION	7
PLATE DATA.....	7
MAX ROOM TEMPERATURE	7
POSITIONING	8
DIMENSIONS	9
TECHNICAL DATA.....	12
WIRING.....	13
CONDENSATE DRAIN	13
TESTING.....	13
CONTROL AND SAFETY SYSTEMS	14
REFRIGERANT MATERIAL SAFETY DATA SHEET	14
DISPOSAL.....	15
OPERATION	16
GENERAL DESCRIPTION	16
SETTING UP	16
MACHINE LOADING.....	17
POSITION OF TRAYS.....	17
CORE PROBE	17
TEMPERATURES	18
LENGTH	18
CONTROL PANEL	19
POSITIVE SOFT QUICK COOLING KEY	19
NEGATIVE QUICK COOLING KEY	19
PROGRAMME	21
PRE-COOLING CYCLE	22
CORE PROBE POSITIVE SOFT QUICK COOLING CYCLE	22
CORE PROBE POSITIVE HARD QUICK COOLING CYCLE	22
CORE PROBE NEGATIVE SOFT QUICK COOLING CYCLE.....	23
CORE PROBE NEGATIVE HARD QUICK COOLING CYCLE	23
TIME-CONTROLLED POSITIVE SOFT QUICK COOLING CYCLE	24
TIME-CONTROLLED POSITIVE HARD QUICK COOLING CYCLE.....	24
TIME-CONTROLLED NEGATIVE SOFT QUICK COOLING CYCLE	25
TIME-CONTROLLED NEGATIVE HARD QUICK COOLING CYCLE.....	25
DEFROSTING	26
CHANGING PARAMETERS	27
ALARMS AND FAULT ANALYSIS.....	28
SIGNALS.....	28
INDICATIONS	29
ALARMS.....	29
ERRORS.....	30
MAINTENANCE	31
MAINTENANCE AND CLEANING	31

CLEANING THE CABINET	31
CLEANING THE AIR CONDENSER	32
STAINLESS-STEEL MAINTENANCE.....	32
DISCONTINUED USE	33
EXTRAORDINARY MAINTENANCE	33
MAINTENANCE OF PANEL BOARD.....	33
CONDENSING SYSTEM MAINTENANCE	35
ENERGY CONSUMPTION CHART.....	36
WIRING DIAGRAM PLATE	37

Annotate the emergency assistance number of specialised maintenance personnel.

Name and Surname	Address	Tel./fax no.

GENERAL INSTRUCTIONS ON DELIVERY

GENERAL WARNINGS

We assure you have made the best choice in purchasing our products and hope you will be fully satisfied with our their performance. To this purpose, we recommend you strictly comply with the instructions and regulations contained in this handbook..

The user is required to carefully read the manual, always referring to it and conserving it in a known place, accessible to all authorised operators.

The equipment is destined only for the function for which it was designed and, being for professional use, must be used only by qualified personnel.

The manufacturer declines all responsibility and any obligation to warranty if damage occurs to the equipment, persons or things, imputable to incorrect installation, inappropriate use by untrained personnel, non specific modifications or interventions, use of non original or non specific replacement parts, failure to observe, even partially, the indications found in this manual.

Please remember that no reproductions of this handbook are allowed. Due to our constant technological updating and research, the features described in this handbook may be altered without prior notice.

LIST OF REGULATION REFERENCES

The cooling cabinet we manufacture fully complies with the following European and national regulations:

2006/42 (machine regulations)
2006/95 (low-voltage regulation)
2004/108 (EMC regulation)
97/23 (PED regulation)
93/68 (new approach regulation)
2002/95 (RoHS regulation)
2002/96 (RAEE regulation)
658/88 CEE
108/89 CEE
DPR 327/80 art.31 (Italy)

D.M. 15-06-71 (Italy)
D.L. n°110 27-01-92 (Italy)
J.O. 16-07-74 n°74-163 (France)

and the following European regulations:

EN55014-1;EN55104-2
EN61000-3-2 ; EN61000-3-3
EN60335-1;EN60335-2-89
EN378-I-II

TRASPORTATION AND HANDLING

For transportation and handling, all precautions necessary must be taken in order not to damage the equipment, referring to the indications found on the packaging of the same.

Make sure that the consignment has not been tampered with or damaged during transport.

UNPACKING

Installation must be carried out by authorised and specialised personnel.

After removing the packaging, ensure the integrity of the equipment and verify that all the parts or components are present and that the characteristics and state correspond to the specifications of the your order.

If not, please inform the retailer immediately.

Remove pvc protective film from all over the appliance.

Attention: all the packing material must be disposed of in accordance with the prevailing regulations in the country where the equipment is used and in any case must not be dispersed into the environment.

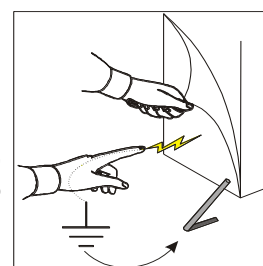
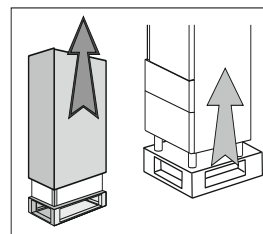

GENERAL SAFETY WARNINGS

The user is responsible for operations carried out on the equipment which do not comply with the indications in this manual, and periodic training of all personnel authorised to work on the equipment is recommended.

List of some general warnings:

- do not touch the equipment with moist or wet hands or feet
- do not insert screwdrivers or kitchen tools or anything else between the guards and the parts in motion
- before any cleaning or maintenance operation, disconnect the equipment from the electrical mains
- do not pull on the power cord to disconnect the machine from the electrical mains
- during loading/unloading of product in the equipment use kitchen gloves
- use the needle probe to read the temperature at the core of the product, making sure to handle it with care

INSTALLATION

PLATE DATA

Make sure the technical wiring specifications comply with the ratings (i.e., V, kW, Hz, no. phases and mains power).

Please quote the product's serial number (shown on the rating plate) on any enquiry to the Manufacturer.

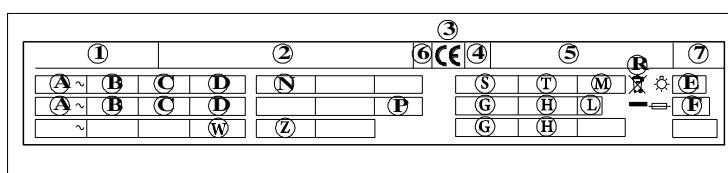

List of rates shown on the rating plate:

- | | |
|---|----------------------------------|
| 1) Model | F) Fuse current |
| 2) Manufacturer's name and address | G) Coolant type |
| 3) CE mark | H) Coolant q.ty |
| 4) Year of make | L) Temperature grade |
| 5) Serial number | M) Max hydraulic supply pressure |
| 6) Power insulation class | N) Room temperature |
| 7) Electrical device casing protection rating | P) Expanding fluid |
| A) Input voltage | R) WEEE Symbol |
| B) Electric current intensity | S) Water inlet temperature a |
| C) Frequency | T) Water consumption |
| D) Rated power | W) Heating unit power |
| E) Total lamp power | Z) Least pressure |

MAX ROOM TEMPERATURE

Air-condenser units should not operate if room temperature is over 38°C. Above 32°C maximum output is not guaranteed.

Min. air circulation

Model	Air q.ty [m ³ /h]
10 kg	1.100
20 kg	3.500
35 kg	4.300

POSITIONING

The appliance must be installed and tested in full compliance with accident-prevention regulations contained in national law and current guidelines. Installers are to comply with any current local regulations.

- Place the appliance onto the required working site.

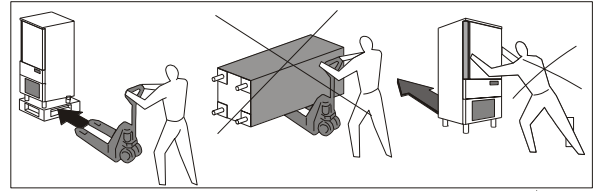

- Avoid locations with exposure to direct sunlight.
- Do not place the appliance in hot, poorly-ventilated rooms.
- Do not place the refrigerated compartment near heat sources.

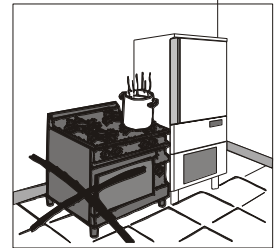

- Leave a min. 100-mm clearance around the appliance on the sides where air inlet and outlet are located.

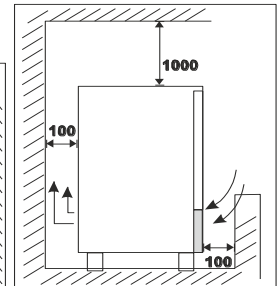
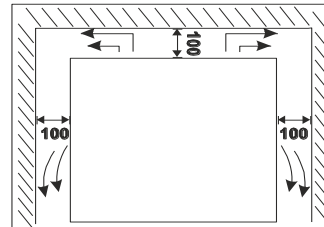

- Level the appliance by means of adjustable feet.

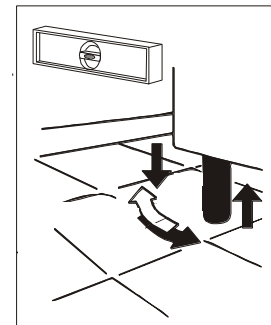

WARNING: If the appliance is not properly levelled the performance and condensate drain may be hampered.

DIMENSIONS

Please refer to the dimensions of your own appliance.

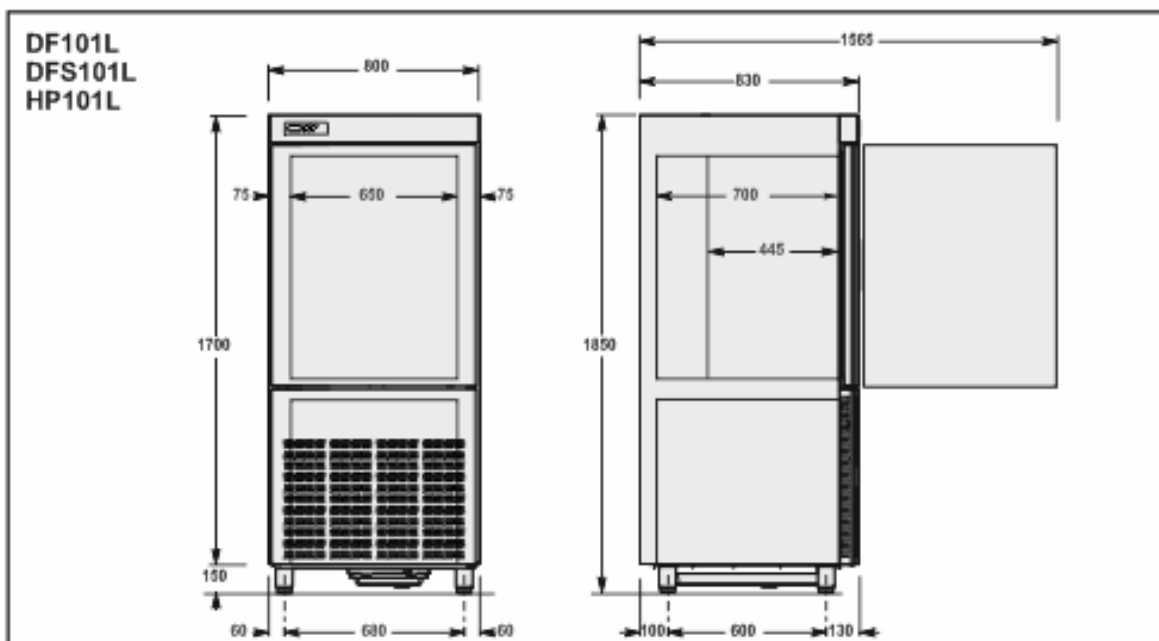
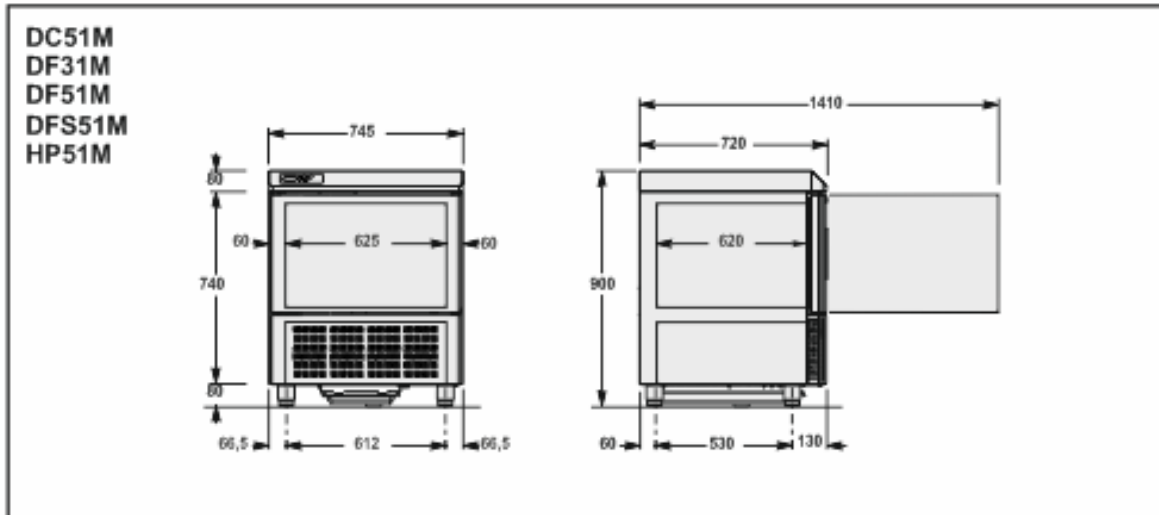
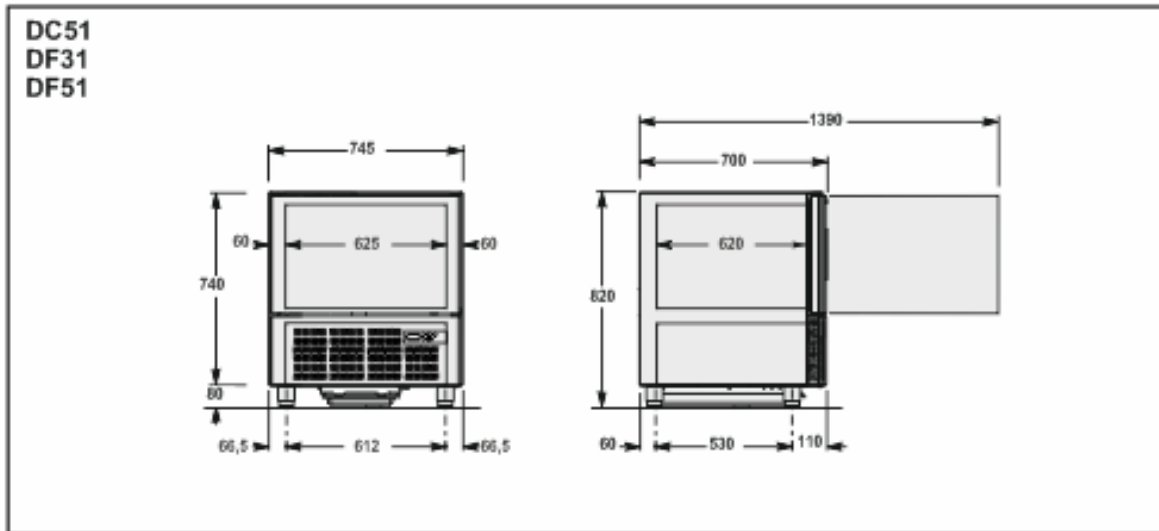

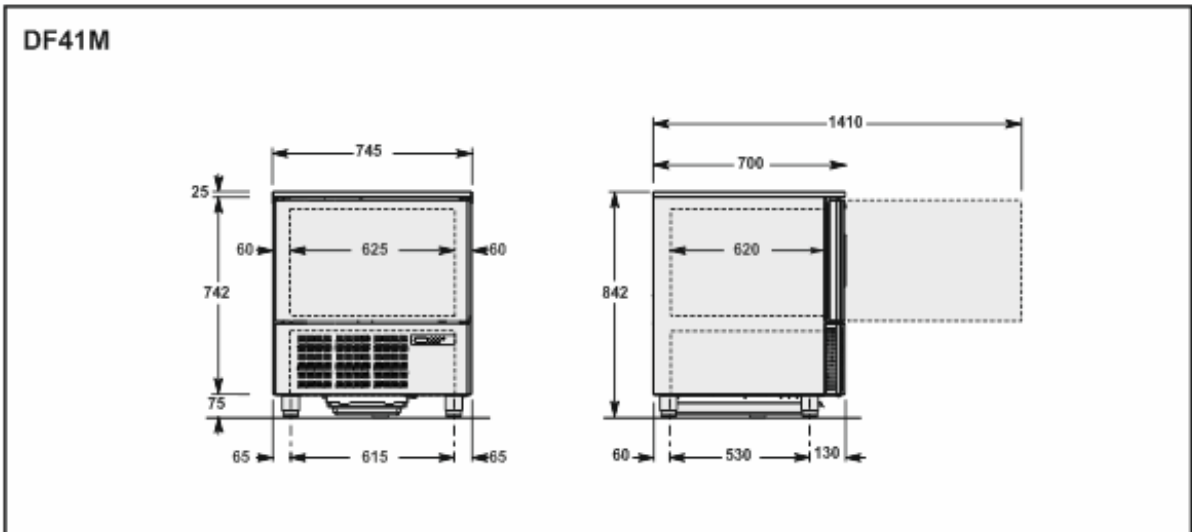
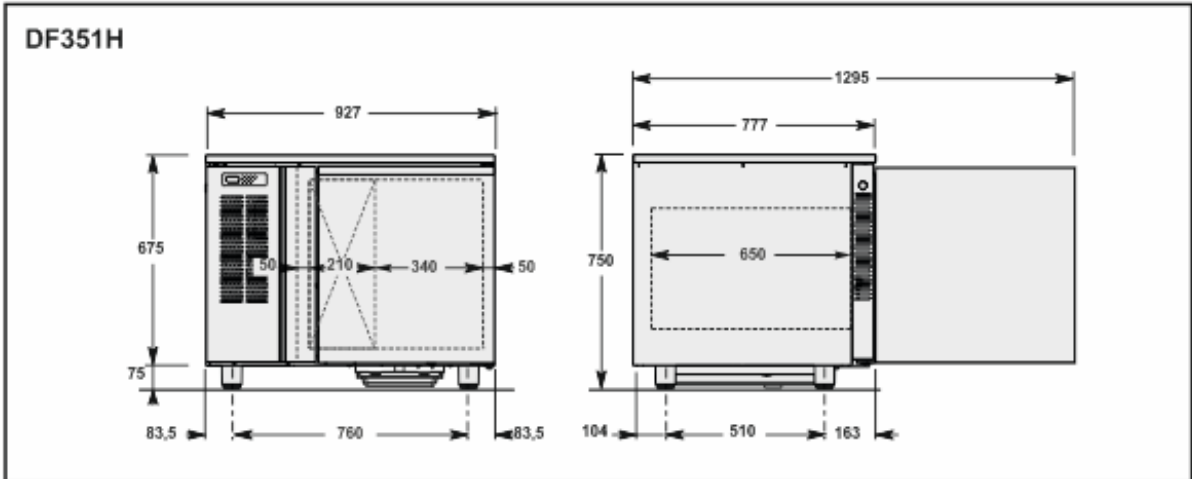
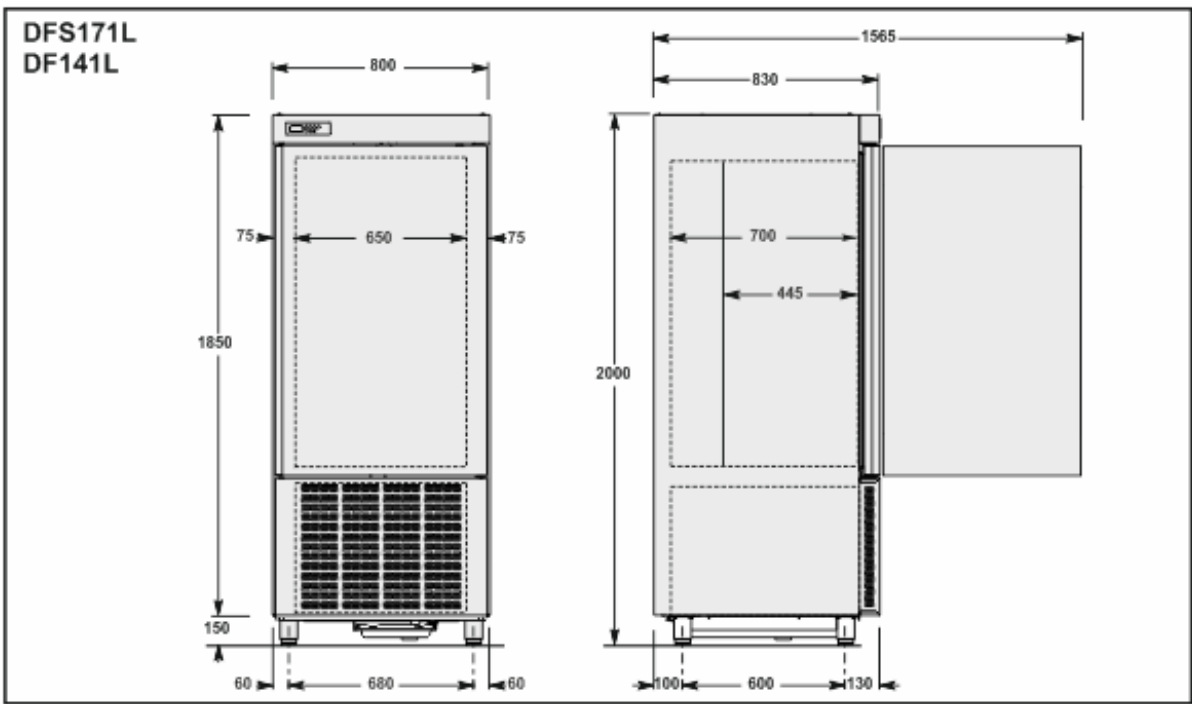

HP102

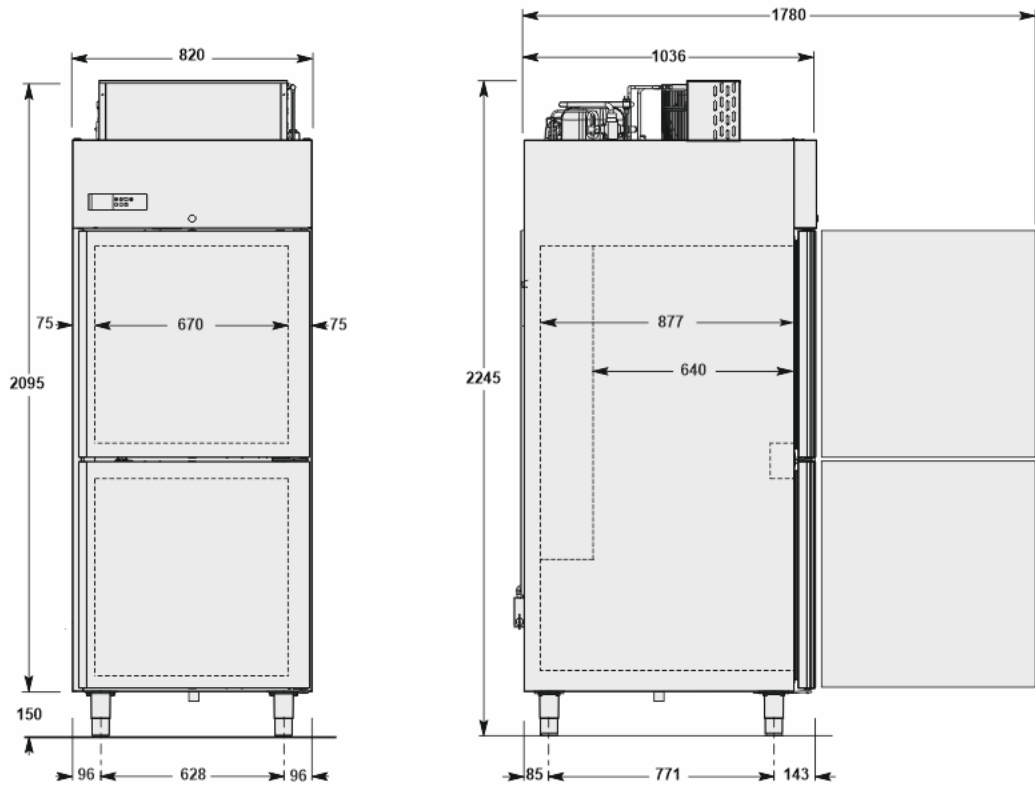

TECHNICAL DATA

Please refer to the technical data of your own appliance.

Model	DC51 - DC51M (10Kg)	DF31 – DF31M (10Kg)	DF351H (10Kg)	DF41M (10Kg)	DF51 - DF51M (10Kg)	DF101L (20Kg L)	DF141L (35Kg L)
Gross weight	125/130	125/130	135	95	125/130	225	255
Net weight	115/120	115/120	120	85	115/120	200	230
Dimensions	745x720x820 745x720x900	745x720x820 745x720x900	927x777x750	745x700x842	745x720x820 745x720x900	800x830x1850	800x830x2000
Capacity							
Mass /cycle (+70°C ÷ +3°C) [kg]	12	10,8	10,8	15	20	42	70
Mass /cycle (+70°C ÷ -18°C) [kg]	-	3,6	3,6	8	12	25	35
Internal volume [l]	90	90	90	90	90	195	270
Rails	GN1/1 600x400	GN1/1 600x400	GN1/1	GN1/1 600x400	GN1/1 600x400	GN1/1 600x400	GN1/1 600x400
Trays	5	5	5	5	5	10	14
Power supply							
Voltage [V]	230V 1N~	230V 1N~	230V 1N~	230V 1N~	230V 1N~	400V 3N~	400V 3N~
Frequency [Hz]	50	50	50	50	50	50	50
Intensity [A]	5,3	4,5	5	5,2	6,2	6	9
Power input [W]	850	750	850	1000	1350	3200	5120
Refrigerating unit							
Refrigerating power [W]	695	577	694	887	887	3136	4369
Evaporation temperature [°C]	-10	-23,3	-23,3	-23,3	-23,3	-23,3	-23,3
Cooling temperature [°C]	+90÷+3	+90÷+3	+90÷+3	+90÷+3	+90÷+3	+90÷+3	+90÷+3
Cooling time [min]	90	90	90	90	90	90	90
Freezing temperature [°C]	-	+90÷-18	+90÷-18	+90÷-18	+90÷-18	+90÷-18	+90÷-18
Freezing time [min]	-	240	240	240	240	240	240
Condensation temperature [°C]	+54,5	+54,5	+54,5	+54,5	+54,5	+54,5	+54,5
Max room temperature [°C]	+32	+32	+32	+32	+32	+32	+32
Compressor type	Ermetic	Ermetic	Ermetic	Ermetic	Ermetic	Ermetic	Ermetic
Coolant	R404A/R452A	R404A/R452A	R404A/R452A	R404A/R452A	R404A/R452A	R404A/R452A	R404A/R452A
Coolant qty [g]	500	450	450	480	1400	2000	2500
Condensation air	Air	Air	Air	Air	Air	Air	Air
Noise [dB] (A)	72	65	65	65	65	72	72
Multi-detector probe	-	•	•	•	•	•	•

Model	HP51M (10Kg)	HP101L (20Kg L)	HP102 (35Kg)	DFS51M (10Kg)	DFS101L (20Kg L)	DFS171L (35Kg L)
Gross weight	130	225	243	130	225	255
Net weight	120	200	223	120	200	230
Dimensions	745x720x900	800x830x1850	820x1036x2245	745x720x900	800x830x1850	800x830x2000
Capacity						
Mass /cycle (+70°C ÷ +3°C) [kg]	-	-	-	25	42	70
Mass /cycle (+70°C ÷ -18°C) [kg]	-	-	-	15	25	35
Mass /cycle (-9°C ÷ -18°C) [kg]	15	27	35	-	-	-
Internal volume [l]	90	195	410	90	195	270
Rails	GN 165x360x120	GN 165x360x120	GN 165x360x120	EN 60x40x4	EN 60x40x4	EN 60x40x4
Trays	6	12	40	6	12	17
Power supply						
Voltage [V]	230V 1N~	400V 3N~	400V 3N~	230V 1N~	400V 3N~	400V 3N~
Frequency [Hz]	50	50	50	50	50	50
Intensity [A]	7,5	6,5	9	6,2	6	9
Power input [W]	1600	4000	5100	1350	3200	5120
Refrigerating unit						
Refrigerating power [W]	1373	3136	4369	887	3136	4369
Evaporation temperature [°C]	-23,3	-23,3	-23,3	-23,3	-23,3	-23,3
Cooling temperature [°C]	-	-	-	+90÷+3	+90÷+3	+90÷+3
Cooling time [min]	-	-	-	90	90	90
Freezing temperature [°C]	-9÷-18	-9÷-18	-9÷-18	+90÷-18	+90÷-18	+90÷-18
Freezing time [min]	70	70	70	240	240	240
Condensation temperature [°C]	+54,5	+54,5	+54,5	+54,5	+54,5	+54,5
Max room temperature [°C]	+32	+32	+32	+32	+32	+32
Compressor type	Ermetic	Ermetic	Ermetic	Ermetic	Ermetic	Ermetic
Coolant	R404A/R452A	R404A/R452A	R404A/R452A	R404A/R452A	R404A/R452A	R404A/R452A
Coolant qty [g]	1400	2000	2600	1400	2000	2500
Condensation air	Air	Air	Air	Air	Air	Air
Noise [dB] (A)	65	72	72	65	72	72
Multi-detector probe	•	•	•	•	•	•

WIRING

An omnipolar switch is to be installed before the appliance, in compliance with the current regulations applied in the country where the appliance is installed.

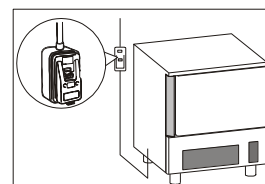

The electrical connection is carried out from the rear part.

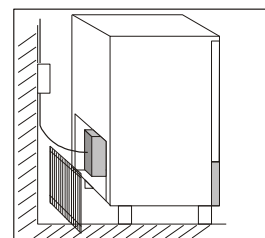

The electrical mains cables must be correctly sized and selected based on the installation conditions.

The 10kg models have 3m of single phase cable (3G 1,5mm²) with a SCHUKO type plug.

The 20/35kg models have 3,5m of three-phase cable (5G 2,5mm²) without plug.

The grounding cable is to be directly connected to a good grounding system.

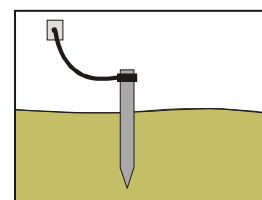

The guarantee will cease and the Manufacturer will not be liable for any damage to appliances or operators arising from the non-compliance with the and tamperings to any part of the appliance (electric, thermodynamic or hydraulic plant).

CONDENSATE DRAIN

The equipment has a condensation collection tray. The tray is extractable from the lower part of the equipment.

TESTING

Should the appliance have been transported horizontally instead of a vertical position DO NOT START THE APPLIANCE IMMEDIATELY. WAIT FOR AT LEAST **24 HOURS** BEFORE OPERATING.

The manufacturer declines any responsibility and any warranty obligation if damage occurs to the equipment imputable to transportation in a horizontal position.

Carry out the following checkings:

- 1) Outside temperatures must be included between 15°C and 38°C.
- 2) Turn on the appliance and wait 30 minutes before the use if the external temperature is "low".
- 3) Check power input
- 4) Carry out at least one full quick cooling cycle

CONTROL AND SAFETY SYSTEMS

The following information concerns skilled staff only.

- **Door micro-switch:** Prevents the appliance from working when the door is open
- **Overall protection fuses:** Protect the whole power circuit from and short-circuits and overloads
- **Compressor thermal relay:** Operates in case of an overload or working failures
- **Motor-fan thermal relay:** Operates in case of an overload or working failures
- **Safety pressure-switch:** Operates in case of coolant over-pressure
- **Cabinet temperature control:** Is run by NTC probe through the relevant electronic card
- **Core temperature control:** Is run by PT100 probe through an electronic card
- **Electronic boards:** based on the parameters entered they command and control any devices connected to the equipment.

REFRIGERANT MATERIAL SAFETY DATA SHEET

1) R404a: fluid components

- trifluoroethane (HFC 143a) 52%
- pentafluoroethane (HFC 125) 44%
- tetrafluoroethane (HFC 134a) 4%

GWP = 3750

ODP = 0

R452A: fluid components

- pentafluoroethane (HFC 125) 59%
- tetrafluoropropene (HFC 1234yf) 30%
- difluoromethane (HFC 32) 11%

GWP = 2141

ODP = 0

2) Hazard identification

Overexposure through inhalation may cause anaesthetic effects. Acute overexposure may cause cardiac rhythm disorders and sudden death. Product mists or sprays may cause ice burns of eyes and skin.

3) First aid procedures

- **Inhalation:** keep injured person away from exposure, warm and relaxed. Use oxygen, if necessary. Give artificial respiration if respiration has stopped or is about to stop. In case of cardiac arrest give external cardiac massage. Seek immediate medical attention
- **Skin:** use water to remove ice from affected areas. Remove contaminated clothes.
CAUTION: clothes may adhere to skin in case of ice burns.
In case of contact with skin, wash with copious quantities of lukewarm water. In case of symptoms (irritation or blisters) seek medical attention.
- **Eyes:** immediately wash with ocular solution or fresh water, keeping eyelids open for at least 10 minutes. Seek medical attention.
- **Ingestion:** it can cause vomit. If conscious, rinse mouth with water and drink 200-300 ml of water. Seek medical attention
- **Other medical treatment:** symptomatic treatment and support therapy when indicated. Do not administer adrenaline or sympathetomimetic drugs after exposure, due to the risk of arrhythmia and possible cardiac arrest.

4) Environmental data

Persistence and degradation

- **HFC 143a:** slow decomposition in lower atmosphere (troposphere). Duration in atmosphere is 55 years.
- **HFC 125:** slow decomposition in lower atmosphere (troposphere). Duration in atmosphere is 40 years.
- **HFC 134a:** relatively rapid decomposition in lower atmosphere (troposphere). Duration in atmosphere is 15.6 years
 - **HFC 143a, 125, 134a:** does not affect photochemical smog (not included in volatile organic components – VOC – as established in the UNECE agreement). Does not cause ozone rarefaction.

Product exhausts released in the atmosphere do not cause long-term water contamination.

DISPOSAL

WASTE STORAGE

At the end of the product life, avoid release to the environment. The doors should be removed before disposal. Temporary storage of special waste is permitted while waiting for disposal by treatment and/or final collection. Dispose of special waste in accordance with the laws in force with regard to protection of the environment in the country of the user.

PROCEDURE FOR ROUGH DISMANTLING THE APPLIANCE

All countries have different legislation; provision laid down by the laws and the authorised bodies of the countries where the demolition takes place are therefore to be observed. A general rule is to deliver the appliance to specialised collection and demolition centres. Dismantle the refrigerator grouping together the components according to their chemical nature. The compressor contains lubricating oil and refrigerant, which may be recycled. The refrigerator components are considered special waste, which can be assimilated with domestic waste. Make the appliance totally unusable by removing the power cable and any door locking mechanisms in order to avoid the risk of anyone being trapped inside.

DISMANTLING OPERATIONS SHOULD BE CARRIED OUT BY QUALIFIED PERSONNEL.

THE SAFE DISPOSAL OF WASTE FROM ELECTRICAL AND ELECTRONIC EQUIPMENT (WEEE DIRECTIVE 2002/96/EC)

Do not dump pollutant material in the environment. Dispose of it in compliance with the relevant laws.

Under the WEEE (Waste Electrical and Electronic Equipment) Directive 2002/96/EC, when scrapping equipment the user must dispose of it at the specific authorised disposal centres, or reassign it, still installed, to the original seller on purchase of new equipment.

All equipment which must be disposed of in accordance with the WEEE Directive 2002/96/EC is marked with

a special symbol .

The improper disposal of Waste Electrical and Electronic Equipment is liable to punishment under the relevant laws in the countries where the offence is committed.

Waste electrical and Electronic Equipment may contain hazardous substances with potential harmful effects on the environment and human health. You are urged to dispose of them properly.

OPERATION

GENERAL DESCRIPTION

The blast chiller is a chilling machine capable of cooling the temperature of a freshly cooked product up to +3°C (positive chilling) and up to -18°C (negative chilling), in order to conserve it for a long period of time without altering the organoleptic characteristics.

Machine capacity as to the quantity to be cooled depend on the model purchased.

SETTING UP

Before setting to operation thoroughly clean the cooling cabinet with a suitable detergent or sodium bycarb dissolved in lukewarm water. Clean the appliance inside to remove any condensate caused by the Manufacturer's final testing.

Cooling and freezing speed depends on the following factors:

- container shape, type and material;
- whether container lids are used;
- foodstuff features (density, water contents, fat contents);
- starting temperature;
- thermal conduction inside the foodstuffs.

Positive /Negative quick cooling time depends on type of foodstuffs to be processed.

In general the programmes the machine is equipped with are based on the chamber temperature management, the fan speed and the chilling time, in any case never exceed 3.6kg of load (for GN1/1, EN1/1 or 60x40 pans) or 7.2kg of load (for GN2/1, EN2/1 or 60x80 pans) and a thickness of 50mm in negative chilling phase and 80mm in positive chilling phase (**table 2**).

Check that the positive chilling programme, up to +3°C at the product core, does not take more than 90 minutes and that the negative chilling programme, up to -18°C at the product core, does not take more than 4 hours.

We recommend pre-chilling the work chamber before beginning with a chilling programme and not covering the food during the programme in order not to increase times.

We recommend using the core probe in order to have the exact core temperature reading. Do not stop the cycle before reaching a temperature of +3°C during positive quick cooling and -18°C during negative quick cooling.

Tab.2

Model	Max. output/cycle		n° max	Capacity		h
	+70[°C]÷+3[°C]	+70[°C]÷-18[°C]		GN	EN	
DC51 - DC51M	12[kg]	-	5	1/1	600x400	40
DF31 - DF31M	10,8[kg]	3,6[kg]	5	1/1	600x400	40
DF351H	10,8[kg]	3,6[kg]	5	1/1	-	-
DF41M	15[kg]	8[kg]	5	1/1	600x400	40
DF51 - DF51M DFS51M	20[kg]	12[kg]	5	1/1	600x400	40
DF101L - DFS101L	42[kg]	25[kg]	10	1/1	600x400	40
DF141L - DFS171L	70[kg]	35[kg]	14/17	1/1	600x400	40
Model	Max. output/cycle		n° max	Capacity		h
		-9[°C]÷-18[°C]				
HP51M	-	15[kg]	6	-	165x360	120
HP101L	-	27[kg]	12	-	165x360	120
HP102	-	35[kg]	40	-	165x360	120

MACHINE LOADING

Do not pile up foodstuffs to be cooled. Thickness should be lower than 50mm in negative quick cooling and lower than 80mm in positive quick cooling.

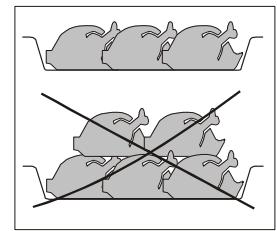

Make sure air circulation is not hampered between food trays.

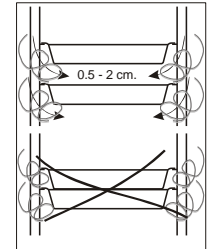

The grid-holding frame (included in those models which include trolleys) is to be located at the centre of the cabinet.

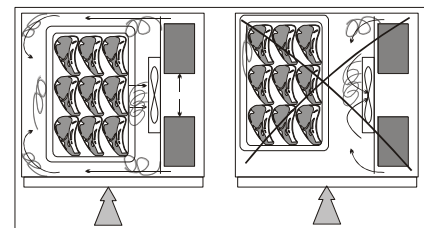

POSITION OF TRAYS

Place the trays as close to the evaporator as possible.

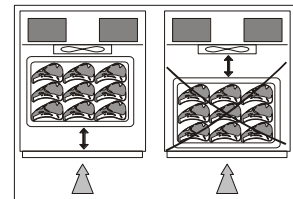

If the cabinet is not full place the trays at equal distance from one another.

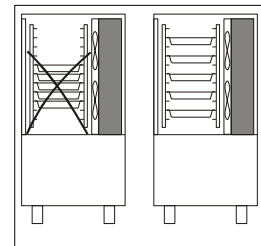

CORE PROBE

For proper position of the probe, refer to the following pictures.

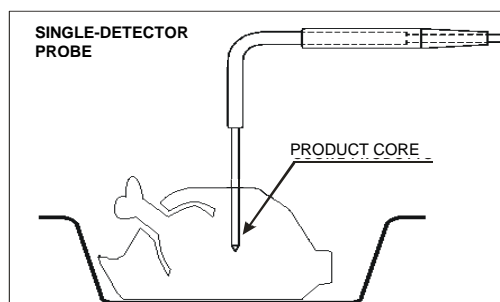

TEMPERATURES

Do not leave the cooked products that are to be chilled/frozen at room temperature.

Avoid humidity losses, which will be detrimental to the conserved fragrance of the product.

We recommend beginning the chilling/freezing programme as soon as the preparation or cooking phase has ended, being careful to insert the product into the equipment at a temperature no lower than +70°C. The cooked product can enter the equipment even at very high temperatures, greater than +100°C, as long as the chamber has been pre-chilled.

In any case it should be taken into consideration that the programme reference times always start from a temperature of +90°C, in positive chilling from +90°C to +3°C and in negative chilling from +90°C to -18°C.

LENGTH

Cooled or frozen processed foodstuffs may be stored in a refrigerator for 5 days of processing with no quality alterations.

For best results we recommend keeping temperature constant throughout the storing (0°C to 4°C), according to the various commodities.

Storing time may be increased to approx. two weeks by using vacuum processing.

After a negative quick cooling cycle, foodstuffs may be stored safely for 3 to 18 months, according to the type of foodstuff processed.

We strongly recommend keeping storing temperature at -20°C or below.

The cooled product should be wrapped in a specific film for foodstuffs (better still, vacuum stored) and provided with a sticker reporting the content [A], date of processing [B] and expiry date [C] written in permanent type ink.

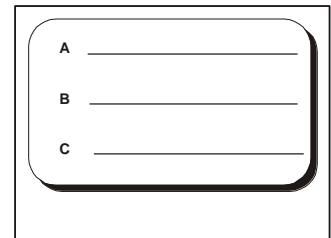







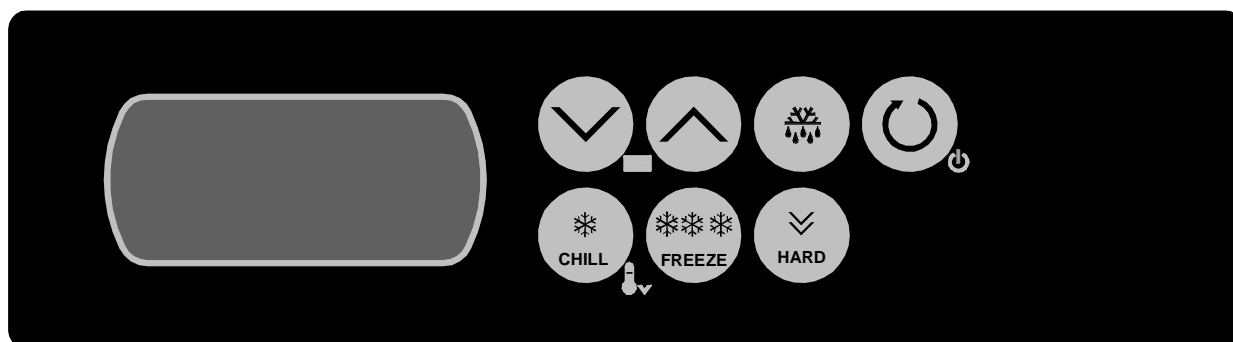





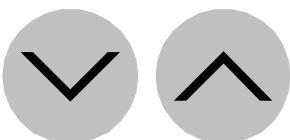



A _____
B _____
C _____

CONTROL PANEL

The illustration shows the equipment control panel, while the list indicates the description and functionality of the individual commands.



	<p><u>STANDBY/ON KEY</u> <i>With the card on standby:</i></p> <ul style="list-style-type: none"> • hold the button down for 1 sec to switch the tab page on <p><i>With the card on stop and the cycle selected:</i></p> <ul style="list-style-type: none"> • press this key once to start the cycle <p><i>With the card set on cycle running:</i></p> <ul style="list-style-type: none"> • press the button once to stop the cycle <p>NOTE: <i>If you hold this key pressed for 3 seconds, you can set the card to Off from any mode.</i></p>
	<p><u>POSITIVE SOFT QUICK COOLING KEY</u> <i>With the card on stop:</i></p> <ul style="list-style-type: none"> • press this key once to select a positive soft quick cooling cycle
	<p><u>NEGATIVE QUICK COOLING KEY</u> <i>With the card on stop:</i></p> <ul style="list-style-type: none"> • press this key once to select a negative quick cooling cycle
	<p><u>HARD QUICK COOLING KEY</u> <i>With selected blast chill cycle</i></p> <ul style="list-style-type: none"> • press the button once to select the positive/negative/Hard chilling cycle
	<p><u>DEFROST KEY</u> <i>With the card on stop:</i></p> <ul style="list-style-type: none"> • hold the button down for 4 seconds to run a defrosting cycle (if necessary)
	<p><u>UP AND DOWN KEYS</u> Use these keys to increase or decrease values <i>With the card on stop:</i></p> <ul style="list-style-type: none"> • hold the  button down for 1 sec to access the probe display menu

	<u>POSITIVE QUICK COOLING LED</u> It is on during positive blast chilling and blinking during selection
	<u>NEGATIVE QUICK COOLING LED</u> It is on during negative blast chilling and blinking during selection
HARD	<u>HARD QUICK COOLING LED</u> It is on during hard chilling, blinking during selection, and on when the function is not active
	<u>CORE PROBE LED</u> It is on during a core probe cycle and blinking during selection or when warning that the needle is not inserted
	<u>TIME LED</u> It is on during a time-controlled cycle and blinking during selection
	<u>STORING LED</u> It is on during the stage after blast chill preservation and blinking during the cycle when the compartment probe is displayed
	<u>DEFROST LED</u> It is on during defrosting and blinking during dripping
	<u>LED PRE-COOLING</u> It is on or blinking during the pre-cooling cycle
	<u>ON/OFF LED</u> It is on when the card is set to stand-by; it is off in any other state of the card
	<u>FAHRENHEIT LED</u> Temperature is measured in Fahrenheit degrees
	<u>CELSIUS LED</u> Temperature is measured in Celsius degrees

PROGRAMME

- **CORE PROBE POSITIVE SOFT QUICK COOLING CYCLE:** cycle suitable for cooling foodstuffs with thickness lower than 4[cm] using a room temperature of about 0[°C]. The cycle is controlled by the core probe.
- **CORE PROBE POSITIVE HARD QUICK COOLING CYCLE:** cycle suitable for cooling foodstuffs with thickness exceeding 4[cm] using a room temperature ranging from -30[°C] to -5[°C]. The cycle is controlled by the core probe.
- **CORE PROBE NEGATIVE SOFT QUICK COOLING CYCLE:** cycle for blast freezing delicate food using an initial chamber temperature around 0[°C]. The cycle is controlled by the core probe.
- **CORE PROBE NEGATIVE HARD QUICK COOLING CYCLE:** cycle suitable for freezing foodstuffs using a room temperature of about -30[°C]. The cycle is controlled by the core probe.
- **TIME-CONTROLLED POSITIVE SOFT QUICK COOLING CYCLE:** cycle suitable for cooling foodstuffs with thickness lower than 4[cm] using a room temperature of about 0[°C]. The cycle is time-controlled.
- **TIME-CONTROLLED POSITIVE HARD QUICK COOLING CYCLE:** cycle suitable for cooling foodstuffs with thickness exceeding 4[cm] using a room temperature ranging from -30[°C] to -5[°C]. The cycle is time-controlled.
- **TIME-CONTROLLED NEGATIVE SOFT QUICK COOLING CYCLE:** cycle for blast freezing delicate food using an initial chamber temperature around 0[°C]. The cycle is time-controlled.
- **TIME-CONTROLLED NEGATIVE HARD QUICK COOLING CYCLE:** cycle suitable for freezing foodstuffs using a room temperature of about -30[°C]. The cycle is time-controlled.

NOTE: At the end of the quick cooling phase, the device starts the storing phase (+2[°C] at the end of the positive quick cooling; -22[°C] at the end of the negative quick cooling).

Cooling time

FOODSTUFF	SHEET	MAX. LOAD	PRODUCT THICKNESS	QUICK COOLING TIME	ROOM TEMPERATURE	CORE TEMPERATURE
FIRST COURSES						
Bechamel	GN1/1 h60	6 lt	4 cm	70 minutes	-20 °C	3°C
Meat broth	GN1/1 h110	8 lt	6-7 cm	110 minutes	-20 °C	3°C
Cannelloni	GN1/1 h40	4 Kg	3-4 cm	40 minutes	-20 °C	3°C
Vegetable soup	GN1/1 h100	5 lt	5 cm	100 minutes	-20 °C	3°C
Fresh pasta	GN1/1 h40	1 Kg	5 cm	20 minutes	-20 °C	3°C
Meat and tomato sauce	GN1/1 h60	5 Kg	5 cm	90 minutes	-20 °C	3°C
Bean soup	GN1/1 h60	5 Kg	5 cm	100 minutes	-20 °C	3°C
Fish soup	GN1/1 h60	4 Kg	5 cm	110 minutes	-20 °C	3°C
MEAT AND POULTRY						
Roast pork	GN1/1 h60	8 Kg	10 cm	110 minutes	-20 °C	3°C
Braised beef	GN1/1 h60	8 Kg	15 cm	110 minutes	-20 °C	3°C
Boiler beef	GN1/1 h60	6 Kg	12-18 cm	110 minutes	-20 °C	3°C
Chicken breast	GN1/1 h40	5 Kg	4-5 cm	30 minutes	0 °C	3°C
Roast-beef	GN1/1 h40	4 Kg	10-15 cm	80 minutes	-20 °C	3°C
FISH						
Baked grouper	GN1/1 h40	3 Kg	5-10 cm	110 minutes	-20 °C	3°C
Squill	GN1/1 h40	2 Kg	3 cm	25 minutes	-20 °C	3°C
Vacuum-stored mussel	grid GN1/1	2 Kg	max 3-4 cm	20 minutes	-20 °C	3°C
Fish salad	GN1/1 h40	4 Kg	3-4 cm	30 minutes	0 °C	3°C
Boiled polyp	GN1/1 h60	5 Kg	-	60 minutes	-20 °C	3°C
Stewed cuttlefish	GN1/1 h60	4 Kg	4-5 cm	60 minutes	-20 °C	3°C
VEGETABLES						
Carrots trifolate	GN1/1 h60	4 Kg	4-5 cm	60 minutes	-20 °C	3°C
Mushrooms trifolati	GN1/1 h60	4 Kg	4-5 cm	60 minutes	-20 °C	3°C
Zucchini trifolate	GN1/1 h60	3 Kg	4-5 cm	90 minutes	-20 °C	3°C
PASTRY/DESSERT						
Vanilla / chocolate pudding	GN1/1 h60	6 lt	4-5 cm	90 minutes	0 °C	3°C
Creme anglaise	GN1/1 h60	3 lt	4-5 cm	100 minutes	0 °C	3°C
Custard a	GN1/1 h60	3 lt	4-5 cm	100 minutes	0 °C	3°C
Panna cotta (single portion)	grid	3 lt	6 cm	60 minutes	0 °C	3°C
Ice-cream cake	grid	3 Kg	4-6 cm	50 minutes	0 °C	3°C
Tiramisù	GN1/1 h60	5 Kg	4-5 cm	45 minutes	0 °C	3°C

PRE-COOLING CYCLE

It is advisable to run a cooling cycle prior to selecting any slaughter cycle.



Press  for 1 sec to run the pre-cooling cycle

The  icon blinks



The pre-cooling cycle continues once the temperature of -25 °C is reached in the chamber, the § remains steady, and the buzzer is activated for 1 sec.

CORE PROBE POSITIVE SOFT QUICK COOLING CYCLE





WARNING: insert the needle probe correctly to run a temperature-controlled cycle.

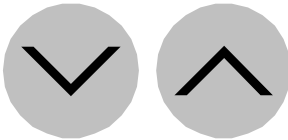

Press the  key to select a core probe positive Soft QC



The  and  icons blink
The display shows the room probe temperature setpoint during QC





Press  or  within 15 seconds to change the value
Use the  and  keys to change the value



Press the  key to start the cycle

The  and  icons remain steady: the test is run to verify the insertion of the core probe

The cycle is run when the test is completed successfully; otherwise, a time-controlled positive soft chilling cycle will start. The  and  icons remain on.

CORE PROBE POSITIVE HARD QUICK COOLING CYCLE

WARNING: insert the needle probe correctly to run a temperature-controlled cycle.



Press the  key to select a core probe positive Soft QC





The  and  icons blink

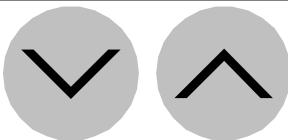

Press the  key to select a core probe positive Hard QC

The **HARD** icon blinks
The display shows the room probe temperature setpoint during QC



Press  or  within 15 seconds to change the value
Use the  and  keys to change the value

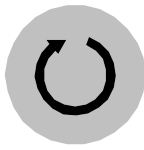

Press the key to start the cycle

The and icons remain steady: the test is run to verify the insertion of the core probe

The cycle is run when the test is completed successfully; otherwise, a time-controlled positive hard chilling cycle will start. The and icons remain on

CORE PROBE NEGATIVE SOFT QUICK COOLING CYCLE

WARNING: insert the needle probe correctly to run a temperature-controlled cycle.



Press the key to select a core probe negative Soft QC

The , and **HARD** and icons blink
The display shows the room probe temperature setpoint during QC

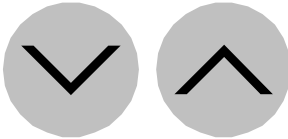

Press or within 15 seconds to change the value

Use the e keys to change the value

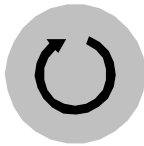

Press the key to start the cycle

The , , **HARD** and icons remain steady: the test is run to verify the insertion of the core probe

The cycle is run when the test is completed successfully; otherwise, a time-controlled negative hard chilling cycle will start. The , , **HARD**, and icons remain on

CORE PROBE NEGATIVE HARD QUICK COOLING CYCLE

WARNING: insert the needle probe correctly to run a temperature-controlled cycle.



Press the key to select a core probe positive Soft QC

The , , **HARD** and icons blink
The display shows the room probe temperature setpoint during QC



Press the key to select a core probe negative Soft QC

The **HARD** icon turns off
The display shows the room probe temperature setpoint during QC

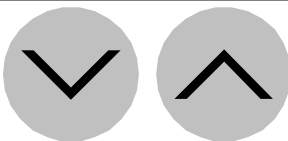





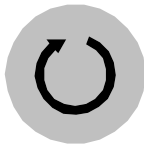

Press or within 15 seconds to change the value

Use the e keys to change the value



Press the  key to start the cycle

The ,  and  icons remain steady: the test is run to verify the insertion of the core probe



The cycle is run when the test is completed successfully; otherwise, a time-controlled negative soft chilling cycle will start. The , , and  icons remain on

TIME-CONTROLLED POSITIVE SOFT QUICK COOLING CYCLE

WARNING: not insert the needle probe correctly to run a time-controlled cycle.





Press the  key to select a core probe positive Soft QC

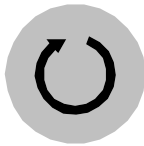

The  and  icons blink
The display shows the room probe temperature setpoint during QC







Press the  key to start the cycle

The  and  icons remain steady: the test is run to verify the insertion of the core probe

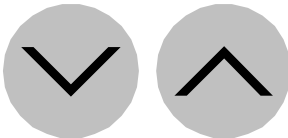
As the needle probe is not inserted, the test is not completed successfully and the time-controlled cycle is launched

The  and  icons remain steady
The display shows the remaining time of the cycle



Press  or  to change the value
Use the  e  keys to change the value

TIME-CONTROLLED POSITIVE HARD QUICK COOLING CYCLE

WARNING: not insert the needle probe correctly to run a time-controlled cycle.



Press the  key to select a core probe positive Soft QC

The  and  icons blink





Press the  key to select a core probe positive Hard QC

The **HARD** icon blinks
The display shows the room probe temperature setpoint during QC







Press the  key to start the cycle

The ,  and **HARD** icons remain steady: the test is run to verify the insertion of the core probe

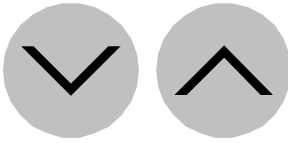
As the needle probe is not inserted, the test is not completed successfully and the time-controlled cycle is launched

The ❄️, 😊 and **HARD** icons remain steady
The display shows the remaining time of the cycle



Press  or  to change the value
Use the  e  keys to change the value

TIME-CONTROLLED NEGATIVE SOFT QUICK COOLING CYCLE

WARNING: not insert the needle probe correctly to run a time-controlled cycle.



Press the  key to select a core probe negative Soft QC

The ❄️, ❄️❄️, **HARD** and  icons blink







Press the  key to start the cycle

The ❄️, ❄️❄️, **HARD** and  icons remain steady: the test is run to verify the insertion of the core probe

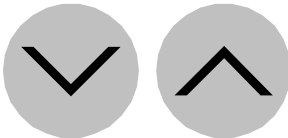
As the needle probe is not inserted, the test is not completed successfully and the time-controlled cycle is launched

The ❄️, ❄️❄️, **HARD** and 😊 icons remain on
The display shows the remaining time of the cycle



Press  or  to change the value
Use the  e  keys to change the value

TIME-CONTROLLED NEGATIVE HARD QUICK COOLING CYCLE

WARNING: not insert the needle probe correctly to run a time-controlled cycle.



Press the  key to select a core probe negative Soft QC

The ❄️, ❄️❄️, **HARD** and  icons blink



Press the  key to select a core probe negative Hard QC

The **HARD** icon turns off
The display shows the room probe temperature setpoint during QC







Press the  key to start the cycle

The ❄️, ❄️❄️, and 😊 icons remain steady: the test is run to verify the insertion of the core probe

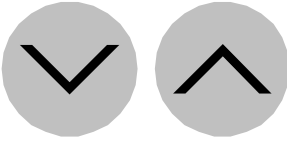
As the needle probe is not inserted, the test is not completed successfully and the time-controlled cycle is launched

*The ❄️, ❄️❄️ and 🕒 icons remain steady
The display shows the remaining time of the cycle*



Press  or  to change the value
Use the  e  keys to change the value

DEFROSTING





Press  for 4 seconds to run the defrosting cycle

The ❄️💧 icon is on, blinking during dripping

CHANGING PARAMETERS

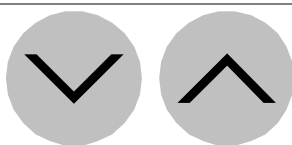
ATTENZIONE: nel caso di utilizzo in utenza di questa funzione, contattare il costruttore.



Press the  and  keys for 4 seconds to gain access to the mode for programming parameters

The display shows "PA"



Press the  key to gain access to service parameters

The display shows the value "0"

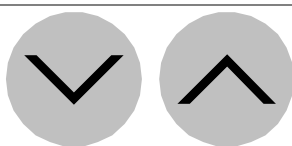

Press  within 15 seconds to set the password "-19"



Press  or do not operate 15 sec

The display shows "PA"

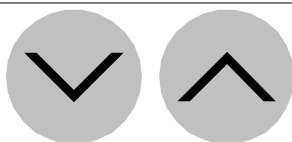

Press the  and  keys for 4 seconds

The display shows "CA1"

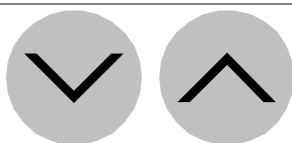



Use the  and  to select a parameter

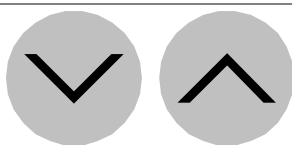

Press  to display the value of the paramete





Press  and  within 15 seconds to change the value of the parameter

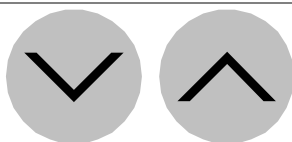

Press  or do not operate for 15 seconds to confirm the new value



Press  and  for 4 seconds or do not operate for 60 seconds to exit the procedure

ALARMS AND FAULT ANALYSIS

If the fault is not corrected by following the above instructions ask for skilled assistance and avoid carrying out any other operations, especially on the electricals. When informing the servicing company of the fault, state 1 and 5 numbers.

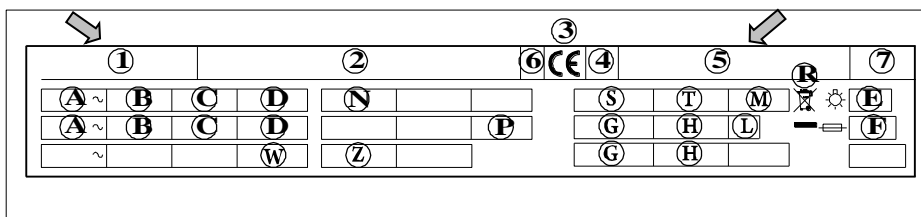

SIGNALS

LED	MEANING
	<p>Positive quick cooling led <i>if it is lit</i>, positive blast chilling in progress <i>if it flashes</i>, you have selected a positive blast chilling and preservation cycle</p>
	<p>Negative quick cooling led <i>if it is lit</i>, negative blast chilling in progress <i>if it flashes</i>, you have selected a negative blast chilling and preservation cycle</p>
HARD	<p>Hard quick cooling led <i>if it is lit</i>, hard chilling in progress <i>if it flashes</i>, you have selected a hard chilling and preservation cycle</p>
	<p>Blast chilling with probe LED <i>if it is lit</i>: • blast chilling with probe in progress <i>if it flashes</i>: • the test to verify the insertion of the probe was not completed successfully • you have selected a blast chill and preservation cycle with probe</p>
	<p>Time-controlled blast chill LED <i>if it is lit</i>: • timed blast chilling in progress <i>if it flashes</i>: • day and time setting in progress • you have selected a timed blast chill and preservation cycle</p>
	<p>Storing LED <i>if it is lit</i>, preservation in progress <i>if it flashes</i>, the compartment probe is displayed during the cycle</p>

- blast chilling with probe in progress

if it flashes:

- the test to verify the insertion of the probe was not completed successfully
- you have selected a blast chill and preservation cycle with probe

- timed blast chilling in progress

if it flashes:

- day and time setting in progress
- you have selected a timed blast chill and preservation cycle

**Defrost LED**

if it is lit, the defrost will be running

if it flashes, the dripping will be running

**Pre-cooling LED**

if it is lit, pre-cooling in progress and cell temperature has reached the one set with parameter r12

if it flashes, pre-cooling in progress and cell temperature has not reached the one set with parameter r12

**LED on/off**

if it is lit, equipment in “standby”

if it is off, equipment in “on”

**LED Celsius degree**

if it is lit, the unit of measure of the temperatures will be Celsius degree

**LED Fahrenheit degree**

if it is lit, the unit of measure of the temperatures will be Fahrenheit degree

min**LED minuti**

if it is lit, time is measured in minutes

INDICATIONS**CODE****MEANING****Loc**

The keyboard is locked

UnL

The keyboard is unlocked

ALARMS**CODE****MEANING****AL****Lower temperature alarm***Remedies:*

- check the cabinet temperature
- look at parameters A1 and A2

Effects:

- no effect

AH**Upper temperature alarm***Remedies:*

- check the cabinet temperature
- look at parameters A4 and A5

Effects:

- the instrument will store the alarm

id **Open door alarm**
Remedies:

- verify the state of the door
- look at parameters i0 and i1

Effects:

- effect determined by the parameter i0

HP **High pressure alarm**
Remedies:

- verify the high pressure inlet conditions
- look at parameters i5 and i6

Effects:

- effect determined by the parameter i5

ERRORS

CODE	MEANING
-------------	----------------

Pr1 **Cabinet probe error**
Remedies:

- look at parameter P0
- check the integrity of the probe
- check the connection instrument-probe
- check the cabinet temperature

Effects:

- equipment in “standby”; no cycle can be selected or started
- during blast chilling, the cycle is interrupted
- during preservation, the compressor activity depends on parameters C4 and C5 or C9
- defrosting is never activated
- the heating elements of the door do not turn on
- the “AL” minimum temperature alarm is never activated
- the “AH” maximum temperature alarm is never activated

Pr2 **Needle Probe Error**
Remedies:

- look at parameter P0
- check the integrity of the probe
- check the connection instrument-probe
- check the cabinet temperature

Effects:

- equipment in “standby”; the blast chill cycles with probe are timed
- during positive blast chilling with probe, the duration of the cycle is established by parameter r1
- during negative blast chilling with probe, the duration of the cycle is established by parameter r2
- heating is interrupted while heating the needle probe

Pr3 **Evaporator probe error**
Remedies:

- look at parameter P0
- check the integrity of the probe
- check the connection instrument-probe
- check the cabinet temperature

Effects:

- if parameter P4 has value 1, the defrost will last the time you will have set with parameter d3
- if parameter F0 is set to 1, parameter F16 has no effect
- if parameter F4 is set to 1, the equipment works as if the parameter were set to 2

MAINTENANCE

MAINTENANCE AND CLEANING

CLEANING THE CABINET

Clean inside the cooling cabinet daily.
Both the cabinet and all the internal components have been designed and shaped to allow washing and cleaning all parts easily.
Before cleaning, defrost the appliance and remove the internal drain.
Disconnect the master switch.
Clean all components (stainless-steel, plastic or painted parts) with lukewarm water and detergent.
Then rinse and dry without using abrasives or chemical solvents.

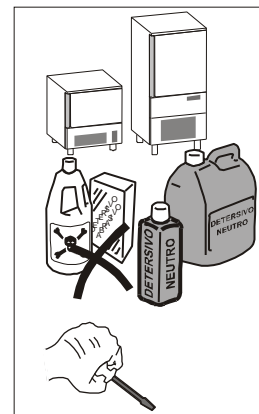

Do not wash the appliance by spraying high-pressure water on the machine.

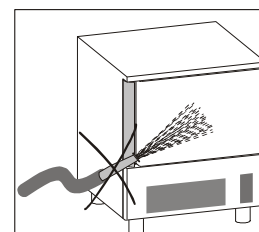

Do not rinse with sharp or abrasive tools, especially the evaporator.

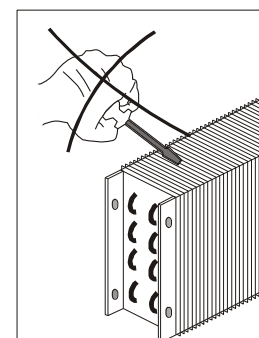

You may clean inside the evaporator after loosening the knobs and rotating the protection component.

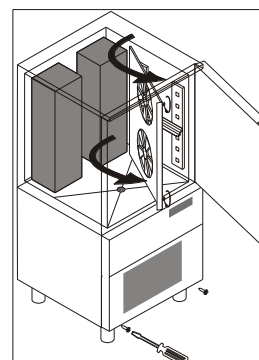

Wash the door gasket with water. Accurately dry with a dry cloth. We recommend wearing protecting gloves throughout the operations.

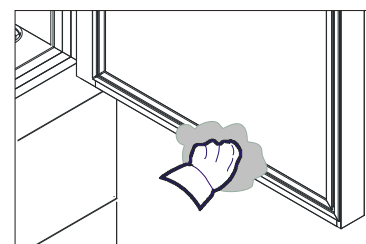

Hand-wash the probe using lukewarm water and a mild detergent or products with biodegradability higher than 90%. Rinse with water and sanitary solution. Do not use detergents containing solvents (such as trichloroethylene, etc) or abrasive powders
ATTENTION: do not use hot water to wash the probe.

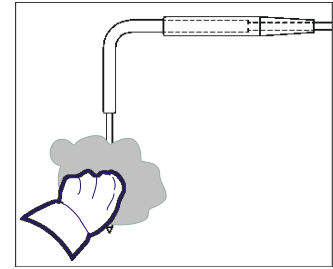

CLEANING THE AIR CONDENSER

The air condenser should be kept clean to ensure the appliance's performance and efficiency, as air should freely circulate inside the appliance.

The condenser should therefore be cleaned every 30 days, using non-metal brushes to remove all dust and dirt from condenser blades.

Access to the condenser is from the front.

Unhook the front guard, pulling it towards you.



In the mod. ... 102 the condensing system is positioned in the upper part of the appliance.

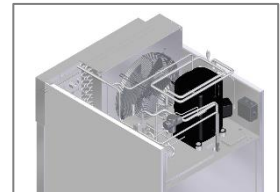

STAINLESS-STEEL MAINTENANCE

By stainless steel we mean INOX AISI 304 steel.

We recommend following the instructions below for the maintenance and cleaning of stainless-steel parts.

This is of the utmost importance to ensure the non-toxicity and complete hygiene of the processed foodstuffs.

Stainless-steel is provided with a thin oxide layer which prevents it from rusting. However, some detergents may destroy or affect this layer, therefore causing corrosion.

Before using any cleansing product, ask your dealer about a neutral chloriness cleansing product, as to avoid steel corrosions.

If the surface has been scratched polish it with fine STAINLESS-STEEL wool or a synthetic-fibre abrasive sponge. Always rub in the direction of the silking.

WARNING: Never use iron wool for cleaning STAINLESS STEEL.

Furthermore, avoid leaving iron wool on the appliance surface as tiny iron deposits may cause the surface to rust by contamination and affect the hygiene of the appliance.



DISCONTINUED USE

Should the machine be disconnected over long periods, follow the instructions below to maintain the appliance in good condition:

Turn the mains switch OFF.

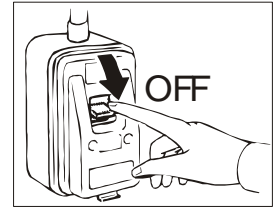

Disconnect the plug.

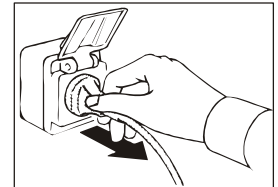

Empty the appliance and clean it in accordance with the instructions given in the chapter "CLEANING".

Leave the door ajar to prevent a bad smell.

Cover the compressor unit with a nylon cloth to protect it from dust.

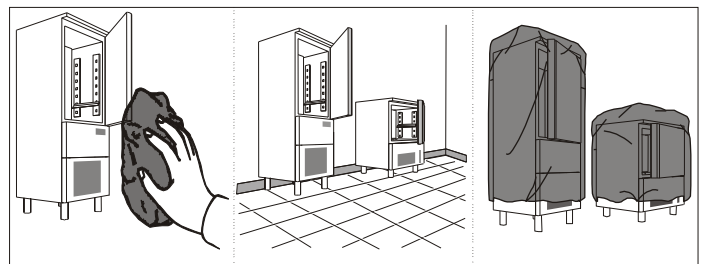

In case of appliances with remote control, if you decide to turn it off, remember to put the switch off also in the remote control..

EXTRAORDINARY MAINTENANCE

The information and instructions in this section are reserved for specialised personnel, authorised to operate on the equipment components.

MAINTENANCE OF PANEL BOARD

Turn the mains switch OFF.

Disconnect the plug.

To be able to access the electric picture:

Mod. ...51... - ...41... - ...31...

Unhook the front guard, pulling it towards you.

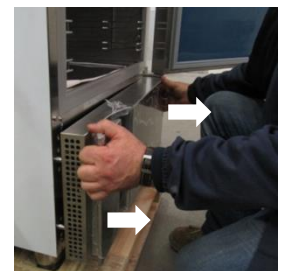

Remove the closing panel screws.
Remove the closing panel.



Remove the electrical panel locking screw.
Move the electrical panel box along the slide.



Mod. ...101L - ...141L- ...171L

Remove the protection panel out in the upper part of the appliance

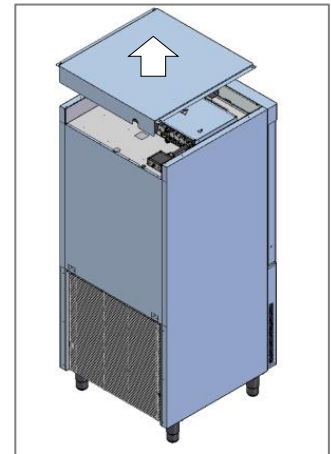

Mod. ...351H

Remove the side panel, undoing the screws.



Mod. ...102

Rotate the dashboard on the side heads by removing the screw under the dashboard.

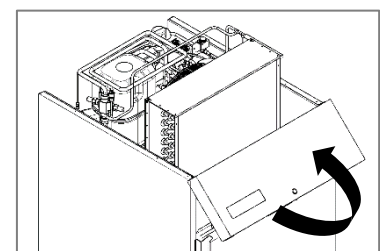

CONDENSING SYSTEM MAINTENANCE

Mod. ...31... - ...41... - ...51... - ...101... - ...141... - ...171...

To access the condensing system, remove the rear protective grille, undoing the screws.



Mod. ...351H

To access the condensing system, remove the side panel, undoing the screws.



Mod. ...102

The condensing system is positioned in the upper part of the appliance.

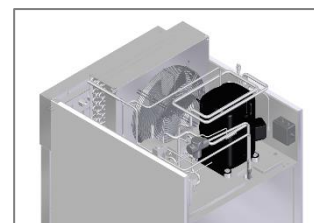

ENERGY CONSUMPTION CHART

	DC51 DC51M	DF31 DF31M	DF351H	DF41M	DF51 DF51M DFS51M	DF101L DFS101L	DF141L DFS171L	HP51M	HP101L	HP102	
Chilled full load capacity [kg]	12	10,8	10,8	15	20	42	70	25	45	70	
Cooling temperature [°C]	+65 ÷ +10										
Time cycle (chilling) [min]	120				110			120			
Energy consumption for chilling [kWh/kg]	0,136	0,143	0,139	0,124	0,089	0,137	0,092	0,082	0,126	0,093	
Frozen full load capacity [kg]	-	3,6	3,6	8	12	25	35	15	27	35	
Freezing temperature [°C]	-					+65 ÷ -18					
Time cycle (freezing) [min]	-					270					
Energy consumption for freezing [kWh/kg]	-	0,824	0,877	0,492	0,313	0,413	0,376	0,33	0,398	0,378	
Refrigerant name	R452A										
GWP	2141										
Refrigerant charge [kg]	0,5	0,35	0,35	0,48	1	2	2,5	1,5	2	2,6	

WIRING DIAGRAM PLATE

The electrical diagram is shown on the last page of the booklet.

N°	DESCRIPTION	N°	DESCRIPTION
1	COMPRESSOR	72	ELECTRONIC DATA CARD LCD
2	CONDENSER FAN	73	FUSE-HOLDER WITH UNIPOLAR FUSE
2A	THERMOSTATED CONDENSER FAN	75	ELECTROVALVE
3	GENERAL TERMINAL BOARD	76	MAGNETIC MICRO-SWITCH
3A	GENERAL TERMINAL BOARD	77	COMPARTMENT PROBE
3B	GENERAL TERMINAL BOARD	78	EVAP./DEFROST PROBE
9	EVAPORATOR FUN	79	NEEDLE CORE PROBE
20	DOOR ANTICONDENSING RESISTOR	79A	MULTIPOINT NEEDLE CORE PROBE
21	DEFROST RESISTANCE	79B	MULTIPOINT PROBE RESISTANCE
21A	DEFROST RESISTANCE	80	PTC RESISTANCE FOR COMPRESSOR CASING
25	TRANSFORMER	86	CONDENSER PROBE
44	RELAY COMPRESSOR	87	LCD QUICK COOLER CARD
65	CONTACTOR	97A	EVAP. FAN CHOKE MODULE
66	THERMAL RELAY	102	BIMETALLIC SAFETY THERMOSTAT
67	EVAPORATOR FAN RUN CAPACITOR	122	LED LAMPS
67A	EVAPORATOR FAN RUN CAPACITOR	127	RGB CONTROLLER
69	GROUNDING TERMINAL	128	USB ADAPTER
70	HIGH PRESSURE PRESSOSTAT	129	ENCODER ADAPTER
71	POWER PANEL ELECTRONIC CARD	132	LED DISPLAY ELECTRONIC BOARD