

**ARMADI FRIGORIFERI  
ARMOIRES FRIGORIFIQUES  
KÜHLSCHRÄNKE  
REFRIGERATORS  
CABINAS FRIGORIFICAS  
KOELKASTEN  
ХОЛОДИЛЬНЫЕ ШКАФЫ**



**ISTRUZIONI ORIGINALI - MANUALE D'USO E INSTALLAZIONE  
INSTRUCTIONS ORIGINALES - MANUEL D'UTILISATION ET D'INSTALLATION  
URSPRÜNGLICHE BEDIENUNGSANLEITUNG - BEDIEN- UND INSTALLATIONSHANDBUCH  
ORIGINAL INSTRUCTIONS - USE AND INSTALLATION MANUAL  
INSTRUCCIONES ORIGINALES - MANUAL DE USO E INSTALACIÓN  
OORSPRONKELIJKE INSTRUCTIES - GEBRUIKS- EN INSTALLATIEHANDLEIDING  
ОРИГИНАЛЬНЫЕ ИНСТРУКЦИИ - РУКОВОДСТВО ПО ЭКСПЛУАТАЦИИ И УСТАНОВКЕ**

IT

Leggere attentamente le avvertenze contenute nel presente libretto in quanto forniscono importanti indicazioni riguardanti la sicurezza, d'uso e di manutenzione.

**Conservare con cura questo libretto per ogni ulteriore consultazione dei vari operatori.**

**Il costruttore si riserva il diritto di apportare modifiche al presente manuale, senza preavviso e responsabilità alcuna.**

FR

Lire avec attention les instructions contenues dans ce livret car elles fournissent d'importants renseignements pour ce qui concerne la sécurité, l'emploi et l'entretien.

**Garder avec soin ce livret pour des consultations ultérieures de différents opérateurs.**

**Le constructeur se réserve le droit d'apporter des modifications à ce manuel, sans préavis ni responsabilité d'aucune sorte.**

DE

Lesen Sie bitte aufmerksam diese Gebrauchsanweisung durch, die wichtige Informationen bezüglich der Sicherheit, dem Gebrauch und der Instandhaltung enthält.

**Heben Sie sorgfältig diese Gebrauchsanweisung auf, damit verschiedene Anwender sie zu Rat ziehen können.**

**Der Hersteller behält sich das Recht, Änderungen dieser Gebrauchsanweisung ohne Ankündigung und ohne Übernahme der Verantwortung vornehmen zu können.**

GB

Carefully read the instructions contained in the handbook. You may find important safety instructions and recommendations for use and maintenance.

**Please retain the handbook for future reference.**

**The Manufacturer is not liable for any changes to this handbook, which may be altered without prior notice.**

ES

Lea atentamente las advertencias contenidas en este manual pues dan importantes indicaciones concernientes la seguridad, la utilización y el mantenimiento del aparato.

**Rogamos guarde el folleto de instalación y utilización, para eventuales futuros usuarios.**

**El constructor se reserva el derecho de hacer modificaciones al actual manual, sin dar algún preaviso y sin responsabilidad alguna.**

NL

Nauwkeurig de waarschuwingen in dit boekje lezen, aangezien zij belangrijke aanwijzingen verschaffen wat betreft de veiligheid, het gebruik en het onderhoud.

**Dit boekje goed bewaren.**

**De fabrikant behoudt zich het recht voor om veranderingen in deze handleiding aan te brengen, zonder voorafgaande waarschuwing en zonder enkele aansprakelijkheid.**

RU

Внимательно читайте предупреждения, содержащиеся в настоящем руководстве, касающиеся надежности использования и обслуживания.

**Конструктор сохраняет за собой право вносить изменения в настоящее руководство без предупреждения и любой ответственности.**

# **INDEX**

<b>SAFETY INFORMATION .....</b>	<b>2</b>
<b>SAFETY PRESCRIPTIONS .....</b>	<b>3</b>
<b>MACHINE DESCRIPTION .....</b>	<b>6</b>
<b>IDENTIFICATION TAG .....</b>	<b>7</b>
<b>DIMENSIONS.....</b>	<b>9</b>
<b>INSTALLATION .....</b>	<b>10</b>
<b>EXTRAORDINARY MAINTENANCE .....</b>	<b>12</b>
<b>GENERAL CLEANING AND MAINTENANCE .....</b>	<b>13</b>
<b>DAILY CLEANING .....</b>	<b>14</b>
<b>WASTE DISPOSAL AND DEMOLITION .....</b>	<b>15</b>
<b>GENERAL NOTES BY THE DELIVERY .....</b>	<b>16</b>
<b>PRESCRIZIONI HACCP .....</b>	<b>16</b>
<b>TECHNICAL SPECIFICATIONS.....</b>	<b>18</b>
<b>CONTROL PANNELS.....</b>	<b>19</b>
<b>TEMPERATURE SETPOINT SETTING/VARIATION .....</b>	<b>20</b>
<b>SMART FUNCTIONS – Quick-access functions.....</b>	<b>20</b>
<b>USER PARAMETER CONFIGURATION - PROBE READING .....</b>	<b>27</b>
<b>DEFAULT PARAMETER RECOVERY .....</b>	<b>28</b>
<b>ALARMS .....</b>	<b>28</b>
<b>INTELLIGENT DEFROST.....</b>	<b>31</b>
<b>ENERGY SAVING.....</b>	<b>31</b>
<b>LOADING THE PRODUCT .....</b>	<b>31</b>
<b>STOPPING .....</b>	<b>32</b>
<b>WORKING IRREGULARITIES.....</b>	<b>32</b>
<b>FOOD STAINS AND HARDENED RESIDUES.....</b>	<b>32</b>
<b>USEFULL ADVICES FOR THE CARE OF THE STAINLESS STEEL.....</b>	<b>33</b>
<b>USAGE INTERRUPTIONS.....</b>	<b>34</b>
<b>MALFUNCTIONING.....</b>	<b>34</b>
<b>INVERTING THE DOOR .....</b>	<b>35</b>
<b>INVERTING THE PANEL COLD STORE DOOR.....</b>	<b>36</b>
<b>REFRIGERANT MATERIAL SAFETY DATA SHEET .....</b>	<b>36</b>
<b>WIRING DIAGRAM .....</b>	<b>38</b>

## SAFETY INFORMATION

**WARNING:** This cabinet contain hydrocarbon refrigerant (R290 or R600a).

**DANGER:** Risk of fire or explosion. Flammable refrigerant used. Do not use mechanical devices to defrost refrigerator. Do not puncture refrigerant tubing.

**DANGER:** Risk of fire or explosion. Flammable refrigerant used. To be repaired only by trained service personnel. Do not puncture refrigerant tubing.

**CAUTION:** Risk of fire or explosion. Flammable refrigerant used. Consult repair manual/owner's guide before attempting to service this product. All safety precautions must be followed.

**CAUTION:** Risk of fire or explosion. Dispose of properly in accordance with federal or local regulations. Flammable refrigerant used.

**CAUTION:** Risk of fire or explosion due to puncture of refrigerant tubing; follow handling instructions carefully. Flammable refrigerant used.

**CAUTION:** Keep clear of obstruction all ventilation openings in the appliance enclosure or in the structure for building-in.

**CAUTION:** For info Max weight distributed on the racks to see product details.



Signal warning of flammability due to the presence of flammable refrigerant (R290 or R600a).

The instructions can be found on the website [www.sagispa.it](http://www.sagispa.it)

### SAFETY PRESCRIPTIONS

The appliance are equipped with a power cord with plug.

**WARNING:** before any maintenance or cleaning operation the machine must be insulated from the current:

- witch the general cut-out in OFF position.

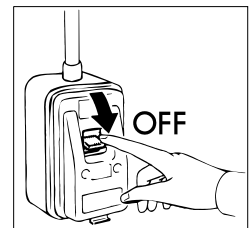

Remove the plug. Removal of the plug must be such that the operator can check its disconnection from each working point.

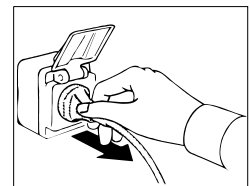

**WARNING:** do not use current taps or plugs not provided with grounding.

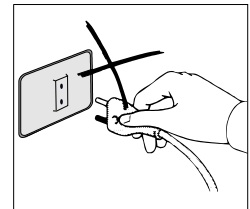

The socket must be provided with GROUNDING.

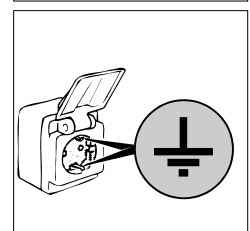

**WARNING:** do not use adapters or patch cords for the connection to the electric line.

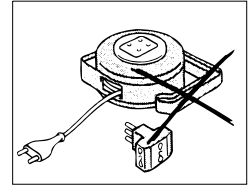

**WARNING:** if the power cord is damaged it must be replaced by a service or qualified personnel to avoid risks.

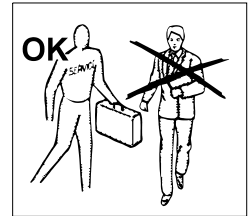

The cleaning and maintenance of the refrigerating engine and the compressor area needs the intervention of a skilled technician, therefore it cannot be done by other persons.

For a maintenance intervention or in case of anomaly disconnect completely the machine; ask for the TECHNICAL SERVICE to an entitled center and the use of original spare parts.

The unfulfilment of this above can endanger the safety state of the refrigerators.

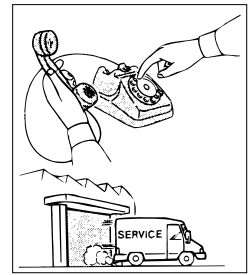

**WARNING:** after its commissioning, wait the time necessary to reach the setted temperature before to introduce the food to preserve.

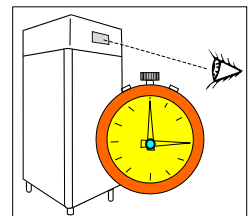

Always cover the food with the special film before to put it into the refrigerator.

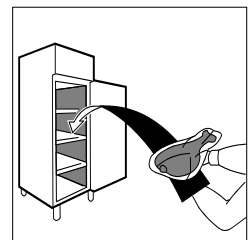

**WARNING:** do not introduce hot foods or drinks into the refrigerator.

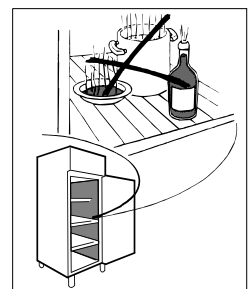

**WARNING:** Store the food to be preserved so as not to brim over the grids. This air flow will not be hampered. Do not obstruct fan intake area.

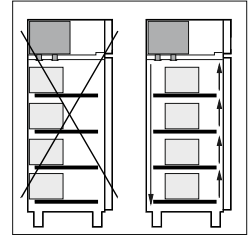

**WARNING:** do not do the cleaning around the refrigerator when the door is open.



Do not wash the appliance by spraying high-pressure water on the machine.

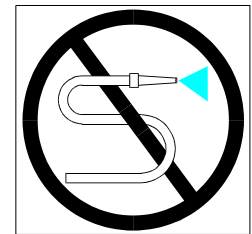

**WARNING:** do not use substances with base of chlorine (chlorine water, muriatic acid, etc.) or however toxic for the cleaning or near the refrigerators.

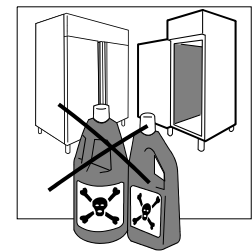

**WARNING:** do not cover the upper side of the refrigerator or the air inlets when the machine is working or live.

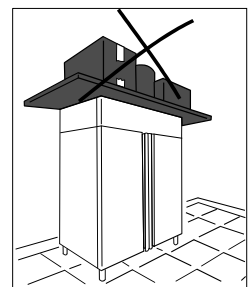

**WARNING:** do not place objects on the refrigerator bottom. Use the grids provided.

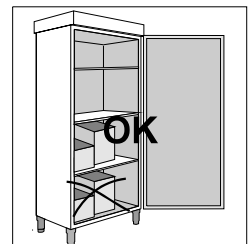

**WARNING:** It is recommended that the keys be kept out of reach of children.

**WARNING:** Do not use mechanical devices nor other means to speed up the thawing process other than those recommended by the manufacturer.

**WARNING:** Do not use electrical appliances inside compartments.



The equipment is designed for a sound pressure level below 70db (A).

### MACHINE DESCRIPTION

This equipment is intended for use in refrigeration and food storage. Any other use is to be considered improper.

**WARNING:** the appliances are not suitable for installation outdoors or in environments subject to the action of the elements. Do not use in potentially explosive atmospheres.

**The manufacturer cannot be held liable for improper use of its products.**

These refrigerating cabinets come with “NORMAL TEMPERATURE” and “LOW TEMPERATURE” refrigerating systems in order to satisfy food preservation at different temperatures.

An refrigerant fluid, approved by current legislation, is used in the refrigerating units.

The appliances are equipped with a fin evaporator protected against oxidation, with a watertight compressor, a branch-aluminium condenser and a relative control panel.

Refrigerators are equipped with similar control panels having different settings depending on the type of appliance (POSITIVE TEMPERATURE, LOW TEMPERATURE)

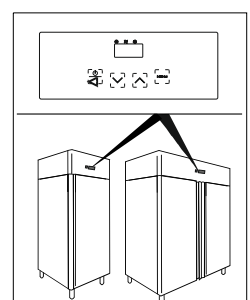
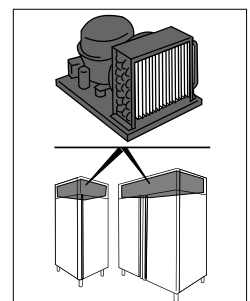



The compressors are installed in the upper part of the cabinets for a better airing and heat dissipation.

Refrigerators are equipped with a tray with a special device for automatic condensate evaporation, located on the appliance upper side.

The lighting system is located on the lower side of the instrument panel

The doors are provided with key to ensure a safe closing.

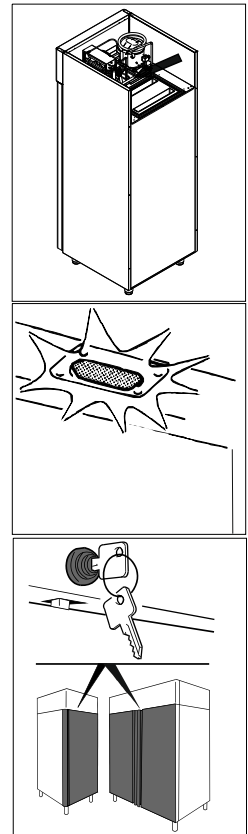

The areas that come into contact with the product are in steel or covered in non-toxic plastic material.

In case of machine downtime, ensure proper ventilation, temperature between -20°C +50°C, relative humidity between 30% and 80% and an atmosphere that is dry and not dusty.

### IDENTIFICATION TAG

For any communication with the manufacturer, always mention the MODEL and the SERIAL NUMBER of the appliance which are reported on the technical feature plate, under the dashboard.

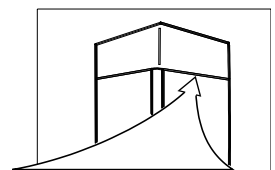

XXXXXX				ANGELO PD	ANGELO PD GRANDI CLINICHE S.p.A. ZONA IND. CAMPOLONGO, 79 ITALIA	EDIZIONE ARCOLI PIRENE AP	CE 70374231601	p. 20	
CONTAINS FLUORINATED FLUIDS INFC COVERED BY KIGOTO PROTOCOL - HERMETICALLY SEALED - FOAM BLOWN WITH FLUORINATED FLUIDS OR CO2									
230 V ~	0.8 A	50 Hz	170 W	-2°C, 8°C					
					HFC245	R600a	0.07 kg	5	ERC
			350 W						
								7 m	
								1.5	1000/17
								6 A	

Refrigerator rating plate containing the following ratings

①		①		②		③		④		⑤		⑥		⑦	
A ~	B	C	D	Z3		Z1				Z	R			E	
A ~	B	C	D			Z2		G	H	L				F	
			W	Y	Z			G	H	M				Z4	

- 1) MODEL
- 2) MANUFACTURARIS NAME AND ADDRESS
- 3) CE MARK
- 4) YEAR OF MAKE
- 5) SERIAL NUMBER
- 6) ELECTRIC INSULATING GRADE
- 7) ELECTRIC PROTECTION GRADE
- A) POWER SUPPLY VOLTAGE
- B) ELECTRIC CURRENT RATE
- C) POWER SUPPLY FREQUENCY
- D) RATED POWER

- E) TOTAL LAMP POWER
- F) FUSIBLE CURRENT
- G) REFRIGERATING FLUID TYPE
- H) REFRIGERATING FLUID QUANTITY
- L) AMBIENT TEMPERATURE
- R) WEEE SYMBOL
- W) HEATING SECTION POWER
- Z1) RATED STORAGE VOLUME (RSV)
- Z2) FLUID FOAMING
- Z3) TEMPERATURE RANGE
- Z4) GWP

<b>Climate Class</b>	<b>Ambient temperature</b>
3 (SN)	+10°C ---> +32°C
4 (N)	+16°C ---> +32°C
4+ (ST)	+16°C ---> +38°C
4+ (SN-ST)	+10°C ---> +38°C
5 (T)	+16°C ---> +43°C
5 (SN-T)	+10°C ---> +43°C

(\* The climatic temperature class indicates the ambient temperature for which the equipment is able to work.

## DIMENSIONS

Please refer to the dimensions of your own appliance.

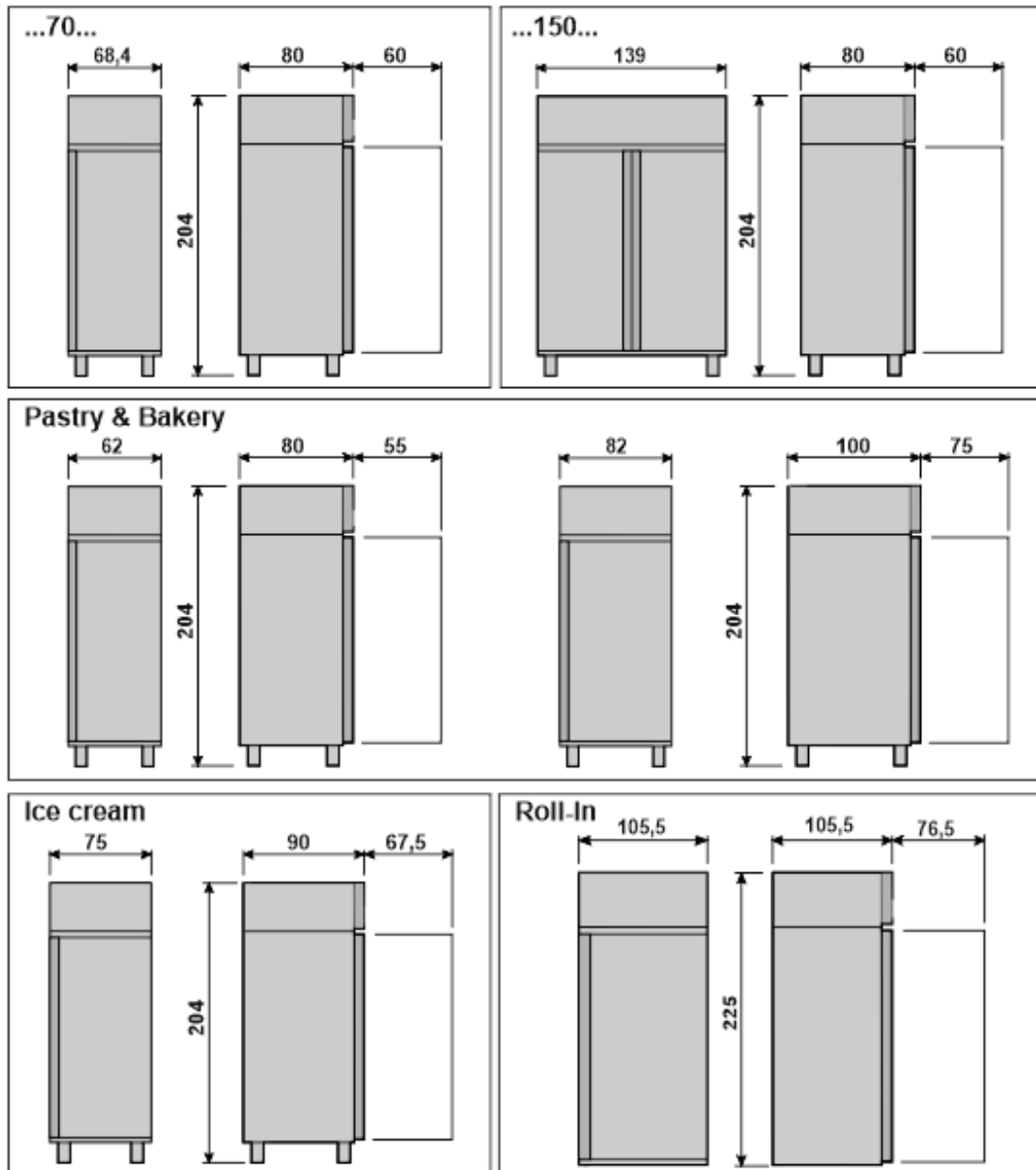

## INSTALLATION

The refrigerators are always send packed and on pallet.

On receiving and after having unpacked in case of dammmages or missing pieces act as described in the chapter "GENERAL NOTES BY THE DELIVERY".

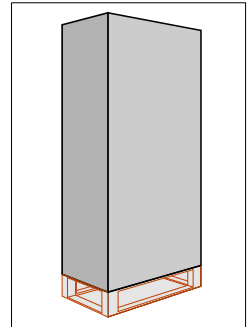

All setting up and starting operations are to be carried out by skilled staff.

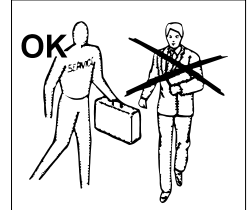

Remove the packing box with care so as not to dent the equipment surface.

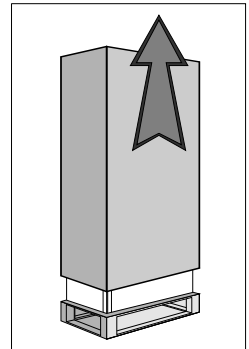

**WARNING:** package parts (plastic bags, polystyrene foam, nails and the like) are dangerous for children and must not be left within their reach.

With a fork truck lift pull up the refrigerator and take it to his place paying attention not to unbalance the load.

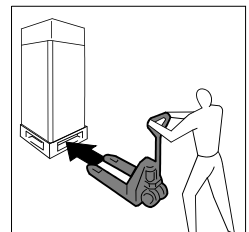

**WARNING:** never place the refrigerator horizontally during transport; this may cause serious structure and system damage.

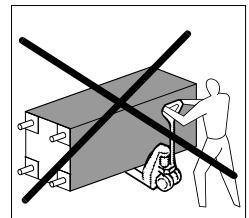

**WARNING:** whether for the positioning or for further replacements do not push

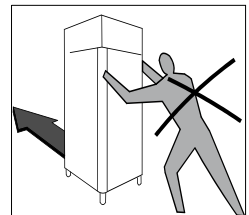

or pull the refrigerator, to avoid to upset it or to damage some parts.

**WARNING:** Do not place the cabinet in the vicinity of heat/ignition sources or in environments with high temperatures and/or highly flammable materials.

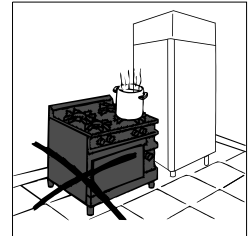

**WARNING:** Allow 2,5 cm between the wall and rear of the refrigerator to assure proper ventilation. For freezers 7,5 cm between the wall and rear of the cabinet will assure proper ventilation. Appliances can be placed next to each other, but in case of condensation space them out 20 cm at least.

Assure a minimum space of 50 cm on from upper side the appliance.

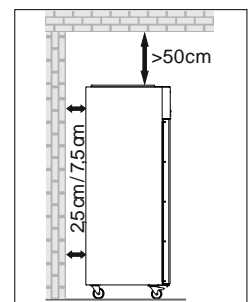

Set unit in its final location.

Be sure there is adequate ventilation in your room. Do not allocate equipment to environments above the declared climate class.



Remove protective film from product.

This may cause unpleasant static electricity discharge which, however, is not dangerous.

The inconvenience is reduced or prevented by continuously holding the refrigerator with one hand or grounding the package.

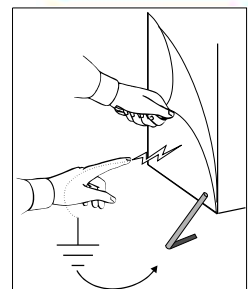

**WARNING:** If the appliance is not properly levelled the performance and condensate drain may be hampered.

Check horizontality with respect to the floor of the appliance with the help of a spirit level.

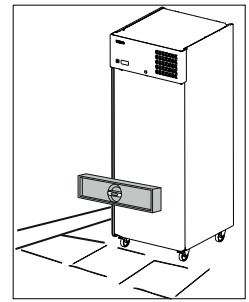

If the floor is uneven, regulate the feet.

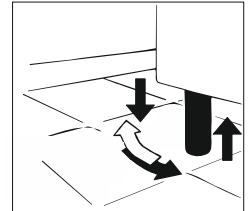

Put the appliance at level by keeping it slightly inclined at its back in order to allow the optimum self-closing door.

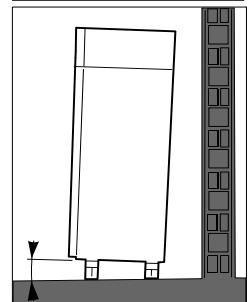

Clean with tepid water and neutral soap (as written in the chapter "CLEANING") and mount the fittings placed into the refrigerator.

Check that the line voltage corresponds to the one referred on the refrigerator's identification tag.

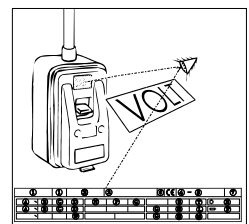

Then insert the plug into the current tap.

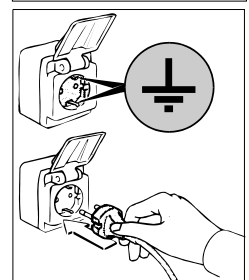

## EXTRAORDINARY MAINTENANCE

*The information and instructions in this section are reserved for specialised personnel, authorised to operate on the equipment components.*

## BULB REPLACEMENT

**WARNING:** Before proceeding with any operation, disconnect the power supply from the appliance.

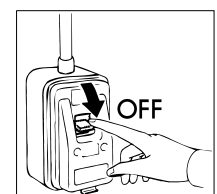

Remove the bulb protection, located under the dashboard, unscrewing the screw.



Replace the burnt bulb with a new one, paying attention to the features shown on the plate.

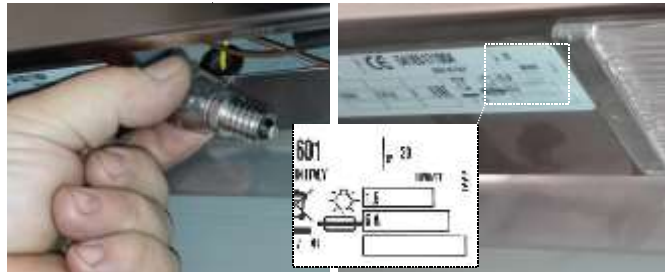

Replace the bulb protection by screwing on the screw.

## MAINTENANCE ELECTRIC BOARD

**WARNING:** Before proceeding with any operation, disconnect the power supply from the appliance.

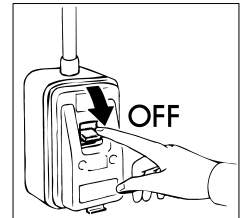

Remove the screw under the dashboard.  
Unhook the dashboard by pulling it towards you.



In model. *“Ice cream – Pastry & Bakery – Roll-In”* rotate the instrument panel on the side heads.

Disconnect all the connections present.  
Proceed to the intervention.



At the end of the operation, hook up all the connections, making sure to follow the instructions on the rating plate and reassemble the dashboard on the appliance.

## GENERAL CLEANING AND MAINTENANCE

For a constant efficiency of the refrigerator it is recommended to perform the cleaning and maintenance operations.

Before to begin with the operations proceed as following:

- set the general cut-out in OFF position
- remove the plug from the socket and wait till the complete defrosting of the refrigerator.

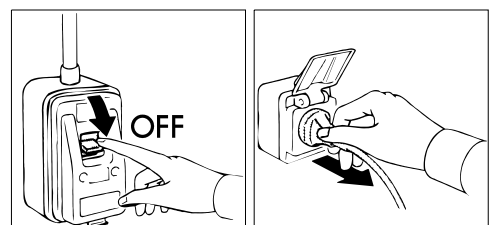

The air condenser should be kept clean to ensure the cabinet's performance and efficiency, as air should circulate inside the cabinet without barrier. The condenser should therefore be cleaned every 30 days or as needed.

Dirty condensers result in compressor failure, product loss, and lost sales, which are not covered by warranty.

Remove the protection panel out in the upper part of the cabinet.

Use a vacuum cleaner, brush or non-metallic brush to carefully clean the condenser of the cooling unit.

Reposition the protection panel out in the upper part of the cabinet.

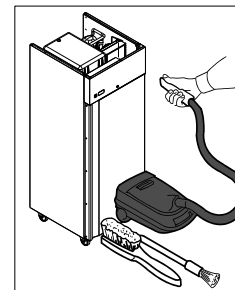

**WARNING:** The cleaning and maintenance of the refrigerating engine and the compressor area needs the intervention of a skilled technician, therefore it cannot be done by other persons.

Clean the external and internal surfaces with water and neutral soap or detergent; a little vinegar in the water will remove eventual bad smells.

Rinse abundantly with pure water and dry up accurately.

The cleaning and maintenance operations have now come to end.

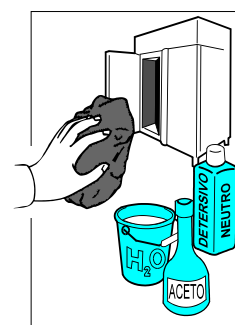

## DAILY CLEANING

To guarantee a perfect hygiene and conservation of the refrigerated cabinet it is recommended to carry out often and/or daily the cleaning operations as indicated hereunder:

1. Carefully wash the external parts only through the satin finish, wiping with a squeezed sponge previously soaked in mild detergent.

2. The detergents must not contain chlorine and must not be abrasive.

2.a The kind of detergents recommended are the ones indicated hereunder:

- Composite action disinfecting detergent; (containing non-ionic surfactants, benzalkonium chloride, chelating agents and pH buffer)
- Laboratory, neutral detergent for hand washing; (containing anionic and non-ionic surfactants)
- Food environments degreasant; (containing anionic surfactants and EDTA)





3. Before using the detergents, dilute them, if needed, following the instructions on the label.
4. Leave the detergents act for at least 5 minutes.
5. Rinse carefully the fridge walls with a sponge drenched in running water.
6. Dry carefully using a clean sponge.

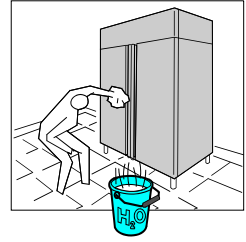

**WARNING:** absolutely do not use utensils or materials which could cause cuts and consequently rust formations.

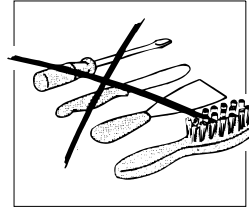

**HYDROCHLORIC ACID (MURIATIC ACID) SHOULD NEVER BE USED ON STAINLESS STEEL.  
REGULARLY RESTORE/PASSIVATE STAINLESS STEEL.**

## WASTE DISPOSAL AND DEMOLITION

### WASTE STORAGE

At the end of the product life, avoid release to the environment. The doors should be removed before disposal.

Temporary storage of special waste is permitted while waiting for disposal by treatment and/or final collection. Dispose of special waste in accordance with the laws in force with regard to protection of the environment in the country of the user.

### PROCEDURE FOR ROUGH DISMANTLING THE APPLIANCE

All countries have different legislation; provision laid down by the laws and the authorised bodies of the countries where the demolition takes place are therefore to be observed.

A general rule is to deliver the appliance to specialised collection and demolition centres. Intervening on the unit is strictly prohibited in the case of the presence of flammable materials. Contact your service centre.

Make the appliance totally unusable by removing the power cable and any door locking mechanisms in order to avoid the risk of anyone being trapped inside.

**DISMANTLING OPERATIONS SHOULD BE CARRIED OUT BY QUALIFIED PERSONNEL.**

### THE SAFE DISPOSAL OF WASTE FROM ELECTRICAL AND ELECTRONIC EQUIPMENT (WEEE DIRECTIVE 2002/96/EC)

**Do not dump pollutant material in the environment. Dispose of it in compliance with the relevant laws.**

Under the WEEE (Waste Electrical and Electronic Equipment) Directive 2002/96/EC, when scrapping equipment the user must dispose of it at the specific authorised disposal centres, or reassign it, still installed, to the original seller on purchase of new equipment.

All equipment which must be disposed of in accordance with the WEEE Directive 2002/96/EC is marked with a special symbol .

**The improper disposal of Waste Electrical and Electronic Equipment is liable to punishment under the relevant laws in the countries where the offence is committed.**

**Waste electrical and Electronic Equipment may contain hazardous substances with potential harmful effects on the environment and human health. You are urged to dispose of them properly.**

## GENERAL NOTES BY THE DELIVERY

At the delivery inspect that the packing is not injured and that it has not been damaged during the transport.

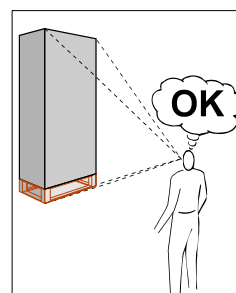

After having unpacked the refrigerator verify that all the parts are present and that the characteristics and the condition correspond to the order specifications.

Otherwise contact immediately the retailer.

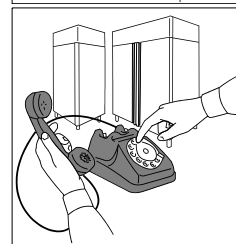

We congratulate you on your choice and we hope that you can use our refrigerating cabinets to their utmost, by following the necessary instructions and precautions contained in this manual.

But, remember that any reproduction of this manual is forbidden and that due to a constant pursuit of innovation and technological quality, the features hereby presented could change without notice.

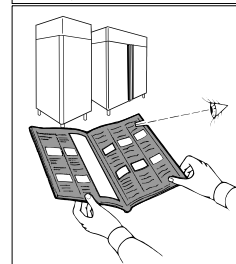

## ACCESSORIES

The appliance can be equipped with the following accessories on request (see "general catalogue").

## PRESCRIZIONI HACCP

**WARNING:** Raw vegetables, eggs and poultry **CANNOT** be kept in the same refrigerated place.

Poultry must be kept in the proper refrigerated place.

**WARNING:** Avoid preserving food with a temperature between 10°C and 60°C.

Make use of the proper appliances (blast chillers) to reduce the temperature to the core of the food.

**WARNING:** When taking the foodstuffs out of the refrigerator, check the expiry date marked on the package, and take out those with the nearest expiry date. If you note an expired food, it has to be kept away from the refrigerator and eliminated, reporting what happened to the person in charge of the firm where you work.

**WARNING:** Easily perishable foodstuffs must be taken out of the refrigerated ambient as late as possible in order to be exposed to room temperature only the necessary time.

**WARNING:** Do not refreeze foodstuffs previously defrosted.

**WARNING:** Number the equipment and check twice a day the temperature taken by recording the figures on a proper sheet to be kept for 24 months.

**WARNING:** Any interruption of current to the refrigerators can be carried out by checking the downtime with an electric clock in order to eliminate the foodstuffs that could perish.

**Maximum temperatures admitted for goods**

<b>Foodstuff</b>	<b>Normal storage temperature (°C)</b>	<b>Maximum temperature of carriage (°C)</b>
Fresh pasteurized milk	0÷+4	9
Fresh cream	0÷+4	9
Yoghurt, ricotta, fresh cheese	0÷+2	9
Frozen fish	0÷+2	0÷+4
Beef and pork	0÷+3	10
Poultry	0÷+4	8
Rabbit	0÷+2	8
Ground-game	0÷+2	8
Big game	0÷+2	8
Offal	0÷+3	8
Frozen food	-23÷-24	-18
Packed ice-cream	-18÷-20	-18
Fruit and vegetables	0÷+4	room temperature



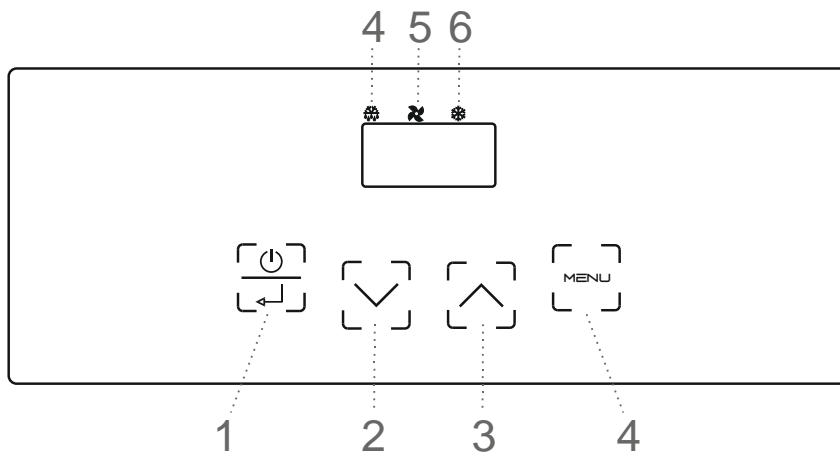

**TECHNICAL SPECIFICATIONS**

Last page on the handbook: technical specifications.

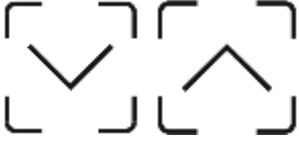

## CONTROL PANNELS



POS	DESCRIPTION
1	ON/SBY/ENTER key
2	DOWN key
3	UP key
4	MENU key
5	DEFROST ICON
6	FAN ICON
7	COMPRESSOR ICON

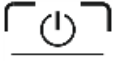
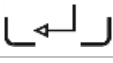
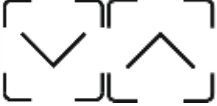

	<p><b><u>ON/SBY/ENTER key</u></b>            Press and release this key to check/change the appliance operation setpoint.            Press this key for 3 seconds and release it as the display shows the <b>[Sby]</b> to set the appliance to the stand-by mode.            Hold this key pressed for over 5 seconds (thus avoiding the Sby label) to gain access to the user parameters list.            When holding device in stand-by pressed [the display shows <b>Sby</b>], the controller turns on.</p>
	<p><b><u>UP and DOWN keys</u></b>            These keys allow to increase or decrease the value of the parameter to be changed.            Press these keys to display the min and max temperature recorded (if available) and any alarm activated.            With the keyboard locked, press these keys simultaneously to unlock.            Press UP for 3 seconds to activate the Hyper Cold function.            Press DOWN for 3 seconds to de-activate the Hyper Cold function.</p>
	<p><b><u>MENU key</u></b>            Press this key for 3 seconds to activate/de-activate the appliance smart function input.</p>
	<p><b><u>DEFROST ICON</u></b>  <i>Led on:</i> defrost in progress  <i>Led blinking:</i> defrost activation delay or dripping in progress  <i>Led blinking at high frequency:</i> alarm memorized</p>
	<p><b><u>FAN ICON</u></b>  <i>Led on:</i> room fans activated  <i>Flashing LED:</i> post-defrosting fans activation delay</p>
	<p><b><u>COMPRESSOR ICON</u></b>  <i>Led on:</i> compressor activated  <i>Led blinking:</i> compressor activation delay</p>

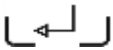
## TEMPERATURE SETPOINT SETTING/VARIATION

 	<p>Press and release the key on/sby/enter: the current setpoint blinks on the display for 5 seconds. After 5 seconds, the displays shows the room temperature again</p>
	<p>While the display is blinking, use the up and down keys to increase or decrease the temperature setpoint</p>
 	<p>Press the key on/sby/enter again to confirm the new setpoint: The new value acquisition is signalled by 3 consecutive, short beeps.</p>

## SMART FUNCTIONS – Quick-access functions

### FORCED MANUAL DEFROST

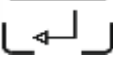

	<p>Hold the key menu pressed for over 3 seconds to gain access to the quick-access function.</p> <p>The display shows the first smart function option. The function [Def / nDf] blinks at high frequency</p>
 	<p>Press the key on/sby/enter to confirm your selection and activate/de-activate the function.</p> <p><i>The forced manual defrost starts only if it is necessary.</i></p>

**Hyper Cold cannot be started during this phase.**

*You can leave the programming phase by waiting for 30 seconds without operating on the card, or pressing  for 5 seconds.*

*In both cases, there you will hear 3 consecutive, short beeps and the display will temporarily show [ESC].*

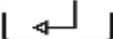

### HYPER COLD

	<p>Hold the key menu pressed for over 3 seconds to gain access to the quick-access function.</p> <p>The display shows the first smart function option. It blinks at high frequency.</p>
	<p>Use the up and down keys to display the function [HCo / nHC].</p>
 	<p>Press the key on/sby/enter to confirm your selection and activate/de-activate the function.</p>

**During this phase, defrost is not performed and you cannot start the Energy Saving system.**



You can leave the programming phase by waiting for 30 seconds without operating on the card, or pressing  for 5 seconds. In both cases, there you will hear 3 consecutive, short beeps and the display will temporarily show [ESC].

**ROOM FAN OPERATION**

	<p>Hold the key menu pressed for over 3 seconds to gain access to the quick-access function.</p> <p>The display shows the first smart function option. It blinks at high frequency.</p>
	<p>Use the up and down keys to display the function [F_C / F_ _] (F_C → 75% / F_ _ → 90%)</p>
	<p>Press the key on/sby/enter to confirm your selection and activate/deactivate the function.</p>

You can leave the programming phase by waiting for 30 seconds without operating on the card, or pressing  for 5 seconds. In both cases, there you will hear 3 consecutive, short beeps and the display will temporarily show [ESC].

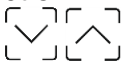

**KEYBOARD LOCK**

	<p>Hold the key menu pressed for over 3 seconds to gain access to the quick-access function.</p> <p>The display shows the first smart function option. It blinks at high frequency.</p>
	<p>Use the up and down keys to display the function [Loc].</p>
	<p>Press the key on/sby/enter to confirm your selection and activate/deactivate the function.</p> <p>Press the keys  simultaneously for over 5 seconds to unlock the keyboard.</p>

You can leave the programming phase by waiting for 30 seconds without operating on the card, or pressing  for 5 seconds. In both cases, there you will hear 3 consecutive, short beeps and the display will temporarily show [ESC].

## PROBE READING MANUAL PRINTING: together with TSP printing terminal



**CAUTION:** This function is only active if parameter L2=1

	<p>Hold the key menu pressed for over 3 seconds to gain access to the quick-access function.</p> <p>The display shows the first smart function option. It blinks at high frequency.</p>
	<p>Use the up and down keys to display the function [<b>Prt</b>].</p>
	<p>Press the key on/sby/enter to confirm your selection and activate/de-activate the function.</p>

You can leave the programming phase by waiting for 30 seconds without operating on the card, or pressing  for 5 seconds. In both cases, there you will hear 3 consecutive, short beeps and the display will temporarily show [**ESC**].

## DOWNLOAD DATA HACCP ON USB PENDRIVE (only for products with standard USB port)

**CAUTION:** This function is only active if parameter L2=2



	<p>Insert the USB flash drive in the port on the control panel.</p> <p>Press the menu key until the [<b>Def</b>] or [<b>ndF</b>] function flashes on the display.</p>
	<p>Use the up and down keys to display the function [<b>dLo</b>].</p>
	<p>Press the on/sby/enter button to activate the data download function on the USB pendrive.</p> <p>During the operation, the display will show "<b>dLo</b>" in steady mode. At the end of data download, the output is signalled by 3 short consecutive beeps and by the temporary appearance on the display of the label [<b>ESC</b>].</p> <p>The display permanently shows the temperature read by the cell probe.</p>

It is advisable to delete data after the download has been completed.













**DELETING HACCP DATA FROM MEMORY (only for products with standard USB port)**











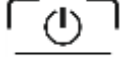
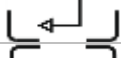

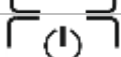
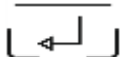

**CAUTION:** This function is only active if parameter L2=2

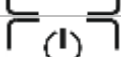
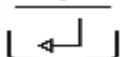
	<p>Press the menu key until the [Def] or [ndF] function flashes on the display.</p>
	<p>Use the up and down keys to display the function [cLo].</p>
	<p>Press the on/sby/enter button to activate the Haccp data deletion function from the memory.</p> <p>During the operation, the display will show " cLo " in steady mode. At the end of data download, the output is signalled by 3 short consecutive beeps and by the temporary appearance on the display of the label [ESC]. The display permanently shows the temperature read by the cell probe.</p>

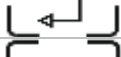
**EDITING / SETTING DATE/TIME (only for products with standard USB port)**

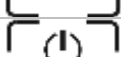
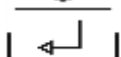
**CAUTION:** This function is only active if parameter L2=2

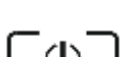
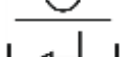







	<p>Press the menu key until the [Def] or [ndF] function flashes on the display.</p>
	<p>Use the up and down keys to display the function [rtc].</p>
	<p>Press the on/sby/enter button to enter device configuration mode (date/time).</p>
	<p>The display will show the string [dd] in steady mode [dd].</p>
	<p>Press the on/sby/enter button to enter into setting mode.</p>
	<p>Use the up and down buttons to set the numerical value corresponding to the day of the month.</p>
	<p>Confirm the value with the on/sby/enter button.</p>
	<p>The display will show the string [dd] again in steady mode.</p>
	<p>Use the up button to select the string [nn].</p>
	<p>Press the on/sby/enter button to enter into setting mode.</p>

	Use the up and down buttons to set the numerical value corresponding to the month of the year.
	Confirm the value with the on/sby/enter button.
	The display will show the string <b>[nn]</b> again in steady mode.
	Use the up button to select the string <b>[yy]</b> .
	Press the on/sby/enter button to enter into setting mode.
	
	Use the up and down buttons to set the numerical value corresponding to the last 2 digits of the current year.
	Confirm the value with the on/sby/enter button.
	The display will show the string <b>[yy]</b> again in steady mode.
	Use the up button to select the string <b>[hh]</b> .
	Press the on/sby/enter button to enter into setting mode.
	
	Use the up and down buttons to set the numerical value corresponding to the current hour.
	Confirm the value with the on/sby/enter button.
	The display will show the string <b>[hh]</b> again in steady mode.
	Use the up button to select the string <b>[nn]</b> .
	Press the on/sby/enter button to enter into setting mode.
	
	Use the up and down buttons to set the numerical value corresponding to the current minutes.
	Confirm the value with the on/sby/enter button.
	The display will show the string <b>[nn]</b> again in steady mode, then it will exit automatically from configuration.
	The output is signalled by 3 short consecutive beeps and by the temporary appearance on the display of the label <b>[ESC]</b> .

You can leave the programming phase by waiting for 30 seconds without operating on the card, or pressing  for 5 seconds.

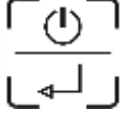
In both cases, there you will hear 3 consecutive, short beeps and the display will temporarily show **[ESC]**.

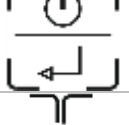
## PARAMETER CONFIGURATION

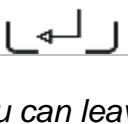
	<p>Hold the key menu pressed for over 3 seconds to gain access to the quick-access function.</p> <p>The display shows the first smart function option. It blinks at high frequency.</p>
	<p>Use the up and down keys to display the function [<b>Par</b>].</p>
	<p>Press the on/sby/enter key to enter the parameter configuration mode.</p> <p>Enter the password to gain access. The display shows the password setting mode [<b>00</b>]</p>
	<p>Use the up and down keys to select the password “<b>65</b>”</p>
	<p>Press the on/sby/enter key to confirm your selection.</p> <p>If the password is correct, the display shows the first parameter in the configuration list.</p>
	<p>Use the up and down keys to scroll the controller parameters</p>
	<p>Press the on/sby/enter key to confirm your selection.</p>
	<p>Use the keys up and down to select the new value</p>
	<p>Press the on/sby/enter key to confirm your selection.</p>

*You can leave the programming phase by waiting for 30 seconds without operating on the card, or pressing  for 5 seconds.  
In both cases, there you will hear 3 consecutive, short beeps and the display will temporarily show [**ESC**].*

## PARAMETERS OF CONFIGURATION





Par	Description	U.M.	min	MAX
<b>MEASUREMENT INPUTS</b>				
/1	Room probe calibration (the parameter is expressed in eighths of degree)	°C	-55	+99
/2	evaporator probe activation (0=off;1=on)	-	0	1
/3	condenser probe activation (0=off; 1=on)	-	0	1
/8	temperature measurement unit (0= degrees fahrenheit, 1=degrees celsius)	-	0	1
/9	aux. output setting : 0 = door resist.; 1 = light com.	-	0	2
/A	door resist. activation setpoint (only if /9 =0)	°C	-55	+99

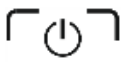
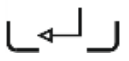
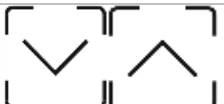

/b	door resist. activation adjustment hysteresis (only if /9 =0)	°C	1	15
/c	automatic enabling of type of defrost depending on the setpoint	-	0	1
/d	unit setpoint above which defrost is conducted by stopping the compressor with auto.adjust. corresp.param.	°C	r1	r2
/E	door resistance activation mode (0 = independent of the compressor 1 = parallel to the compressor)	-	0	1
Pr	room probe reading	°C	-	-
Pd	defrost/evaporator probe reading	°C	-	-
Pc	condenser probe reading	°C	-	-
<b>REGOLAZIONE COMPRESSORE, ENERGY SAVING, HIPER COLD</b>				
r0	adjuster hysteresis (differential)	°C	1	15
r1	min. operating setpoint selectable	°C	-55	r2
r2	max. operating setpoint selectable	°C	r1	+99
r3	temperature increase above setpoint for energy saving : 0= excluded	°C	0	+99
r4	monitoring time for energy saving start	h	0	99
r5	temperature decrease below setpoint for hiper cold : 0= excluded	°C	-55	0
r6	time limit of setpoint persistence in hiper cold	h	0	99
r7	time deviation allowed as to comp. cycle ON. Optimum	min	0	240
r9	min. Δt as to comp. cycle ON for non-efficient cycle definition	min	0	240
rA	max. Δt as to comp. cycle ON beyond which the cycle is not consid.	min	0	240
Rb	min. time deviation allowed for ΔTe function	°C/min	0	+99
Rc	max. number of low-efficient compressor cycles	-	1	3
rL	max. time limit for defrost start in the first phase (0= excluded)	min	0	240
<b>COMPRESSOR PROTECTION</b>				
C0	compressor activation delay from device start	min	0	240
C2	min. delay between compr. stop and subsequent start	min	0	240
C5	compressor start cycle time in the event of room probe alarm	min	1	240
C6	C5 % where compr. starts in the event of room probe alarm	%	0	100
<b>DEFROST</b>				
d0	defrost interval (0= excluded)	h	0	99
d1	defrost type (0= resistance, 1= hot-gas)	-	0	1
d2	end-of-defrost temp. (relating to evaporator temper.)	°C	-55	+99
d3	max. defrost duration (0= defrost never activated)	min	0	99
d6	defrosting display (0=actual cell temperature, 1=stopped cell temperature, 2=dEF label)	-	0	2
d7	dripping time	min	0	15
dE	defrost interval count: 0= actual hours; 1=hours comp. ON; 2= autodeterm.	-	0	2
dP	protection defrost interval (0= de-activated)	h	0	72
<b>ALARMS</b>				
A0	alarm hysteresis (differential)	°C	1	15
A1	min. operating setpoint alarm (0= excluded)	°C	-55	0
A2	max. operating setpoint alarm (0= excluded)	°C	0	+99
A3	alarm exclusion from device start	min	0	240
A4	buzzer activation mode for alarm : 0= always; 1= timer-controlled	-	0	1
A5	time limit for buzzer acoustic signal (only if A4 = 1)	min	0	240
A6	temperature alarm exclusion time (only if A1 and/or A2 ≠0)	min	0	240
A7	temp. alarm exclusion time after evap. stop (for A1 and/or A2 ≠0)	min	0	240
<b>EVAPORATOR FAN ADJUSTMENT</b>				
F1	temper. above which the evap. fan stops ( only if /A = 1 and F7 = 3 or 4)	°C	-55	+99
F2	fan differential (relating to F1, only if /A = 1 and F7 = 3 or 4)	°C	1	15
F3	evaporator fan running during normal operation (0 = OFF; 1= ON; 2 = parallel to compressor; 3 = set with F1, F2 and FF; 4= set with F1, F2 and FF with	-	0	4

	compressor ON and OFF with compressor OFF, 5 = set with F1, F2 and FF with compressor ON and also timed with compressor OFF with Fc deactivation delay upon compressor shut-down and intermittent operation according to times assigned to Fd and FE)			
<b>F4</b>	evap. vent. operation during defrost and dripping (0= OFF, 1= ON, 2= determ. with F7)	-	0	2
<b>F5</b>	evaporator fan stop after dripping	min	0	15
<b>F6</b>	temperature below which the condenser fan turns off	°C	-55	+99
<b>F7</b>	condenser fan differential (relating to F6)	°C	1	25
<b>F8</b>	condenser fan func. during regular operation (0=parallel with compr.; 1=ON); also refer to F6 and F7	-	0	1
<b>F9</b>	condenser fan func. during defrost and dripping (0=OFF; 1=ON, 2=ON if Tc≥35°C and OFF if Tc<33°C)	-	0	2
<b>FA</b>	critical temperature for signalling high condensation temperature	°C	-55	+99
<b>Fb</b>	critical temperature for high pressure akarm	°C	-55	+99
<b>Fc</b>	evaporator fan deactivation delay upon compressor shut-down (only if F3 = 5)	s	0	240
<b>Fd</b>	evaporator fan ON time with compressor off (only if F3 = 5)	s	0	900
<b>FE</b>	evaporator fan OFF time with compressor off (only if F3 = 5)	s	0	900
<b>FF</b>	temperature difference between cell and evaporator for fan activation in continuous mode	°C	0	+99
<b>PRINT/DATA DOWNLOADING</b>				
<b>P0</b>	Enable device numerical identification for data printing/downloading (0 = no, 1 = yes)	-	0	1
<b>P1</b>	Sampling time (see also parameter P6)	-	1	60
<b>P2</b>	Selection of temperature probes for which the read value shall e printed/downloaded (0 = none, 1=chamber probe, 2 = chamber and evaporator probe, 3 = all)	-	0	3
<b>P3</b>	Payslip heading selection (0 =excluded, 1= Refrigerator, 2=Refrigerated counter)	-	0	2
<b>P4</b>	Enable device numerical identification for data printing/downloading (0 = no, 1 = yes)	-	0	1
<b>P5</b>	Selection of language for payslip heading (1 = Italian, 2 = English, 3 = French, 4 = Spanish, 5 = German)	-	-1	5
<b>P6</b>	Configuration parameters printing enable (0 = disabled)	-	1	2
<b>COMMUNICATIONS MANAGEMENT</b>				
<b>L1</b>	Instrument address (date detected in printing phase if P4 = 1)	-	0	256
<b>L2</b>	Serial port management (o = not utilised, 1 = print, 2 = download data on USB/RTC data logger)	-	0	1
<b>L3</b>	Baud Rate data transmiss. (1=2400, 2=4800, 3=9600, 4=18200)	-	1	4
<b>L4</b>	Transmission control mode (0 = no parity, 1 = odd, 2 = even)	-	0	2

## USER PARAMETER CONFIGURATION - PROBE READING

	Press the on/sby/enter key over 5 secods (thus avoiding Sby) to gain access to probe reading and user parameter list.
	The display shows the first label "Pd"
	Use the up and down keys to scroll probe and parameter reading.

	<p>Press the on/sby/enter key to confirm your selection and enter the mode for reading probes or changing parameters.</p> <p>The current value blinks on the display.</p> <p>Use the keys   to select the new value, applicable to parameters only.</p>
	<p>Press the on/sby/enter key to exit or confirm the selection of the parameter new value; the setting stops blinking.</p>

You can leave the programming phase by waiting for 30 seconds without operating on the card, or pressing   for 5 seconds. In both cases, there you will hear 3 consecutive, short beeps and the display will temporarily show [ESC].

## DEFAULT PARAMETER RECOVERY

*Information accessible to qualified staff only*

	<p>On starting the appliance, a “LAMPTEST” phase will start. If you press the on/sby/enter key 3 times consecutively during this phase, all default parameters will be reset.</p> <p>The display shows [rLd] indicating the reset of the values pre-set by the manufacturer.</p>
---	--

**ATTENTION:** the default values in memory refer to the configurations (TN, BT) exclusively.

## ALARMS

### APPLIANCE WITH BROKEN PROBES

**Room probe error**

If the room probe is broken or the relevant connection interrupted, the display shows the label [E0].

The appliance keeps operating in storing according to the values given to parameters C5 and C6.

The inner fan keeps operating according to the value given to F7.

The defrost control is automatically inhibited and the card self-calibration process deactivated.

**Evaporator fan error**

If the evaporator probe is broken or the relevant connection interrupted, the display shows the label [E1].

Defrost starts after a period of time set through “d0” starting from the last defrost cycle.

The inner fan operates according to the value given to parameter F3.

The defrost control is automatically inhibited and the card self-calibration process deactivated.

**Condenser probe error**

If the condenser probe is broken or the relevant connection interrupted, the display shows the label [E2].



The condenser fan keeps operating according to the value given to parameter “F8”.

*If the room probe is broken, neither the Hyper Cold nor the Energy Saving function can be activated.*

*If the three probes are broken or disconnected, E0, E1, and E2 alternate on the display.*



**HIGH TEMPERATURE ALARM**

	<p>If the room temperature exceeds the setpoint, the label [AH] and the temperature reached alternate on the display. The buzzer sounds.</p> <p>Press up to display the duration of the event causing the alarm.</p>
--	--





The buzzer can be turned off by pressing the key    
 The visual alarm signal stays on until the temperature returns within the normal range.

**LOW TEMPERATURE ALARM**

	<p>If the room temperature is below the setpoint, the label [AL] and the temperature reached alternate on the display. The buzzer sounds.</p> <p>Press down to display the duration of the event causing the alarm.</p>
---	---

The buzzer can be turned off by pressing the key    
 The visual alarm signal stays on until the temperature returns within the normal range.





**HIGH AND LOW TEMPERATURE ALARMS MEMORIZED**

	<p>The defrost led blinking at high frequency indicates high or low temperature alarm.</p>
	<p>The temperature reached blinks on the display</p>
	<p>The duration of the event causing the alarm, expressed in minutes, blinks on the display.</p>
	<p>The defrost led is reset to standard operation              The display shows [rES] after the abnormal event.</p>

If the high temperature alarm is on, the compressor keeps working; if the low temperature alarm is on, the compressor stops.

**! If the card is set to the stand-by mode, the min. / max. temperature memorized and any alarms will not be saved.**

**BLACKOUT ALARM**

	The defrost led blinking at high frequency indicates a blackout
	The display shows [bL O].
	The display shows the max. room temperature memorized.
	The defrost led is reset to standard operation.
	The display shows [rES] after the abnormal event.

**HIGH CONDENSATION TEMPERATURE ALARM**

If the condensation temperature is too high, due to dirty condenser, the label [HtC] and the room temperature alternate on the display.  
The buzzer sounds.

The buzzer can be turned off by pressing the key   
The visual warning signal stays on until the condensation temperature returns to normal range.

**HIGH PRESSURE ALARM**

If the refrigerating appliance pressure is above the specified limit, the label [HP] and the room temperature alternate on the display.  
The buzzer sounds.

The buzzer can be turned off by pressing the key   
The visual warning signal stays on until the card is set to stand-by.

**! If the problem causing the alarm reoccurs on restarting the system, the signal [HP] will be displayed again.**

In this case, all the relay outputs are de-activated except the condenser fan output.



## INTELLIGENT DEFROST

**INTELLIGENT DEFROST:** a totally automatic system allowing to start defrost cycles only if it is necessary.

In pursuance of an energy saving policy and for best foodstuffs storing, defrost cycles are automatically performed not at pre-set intervals but according to the evaporator state.

The control card is able to monitor operation through some functional parameters: defrost starts only if it is really necessary, which basically depends on the type of use of the appliance and on the type of foodstuffs stored.

## ENERGY SAVING

**ENERGY SAVING:** a totally automatic system which allows energy saving through the use of the appliance.

This system operates when the appliance is not being used, with door closed, and constant inside temperature close to the setpoint value.

This function stops in the following cases:

- manual or automatic defrost activation
- manual activation of Hiper Cold function
- room temperature reading out of the set parameters
- operation with faulty room probe
- manual variation of the room setpoint
- different setting of evaporator fan operation

## LOADING THE PRODUCT

- Now and not before it is possible to put the food to conserve into the refrigerator.
- Place the products into the cell uniformly to allow a good internal air circulation across the cell.
- Avoid obstructing the ventilation areas inside the refrigerator.
- Only load the top shelf up to the stacking mark.
- Do not place products below the bottom shelf support.
- Cover or wrap food before introducing it into the refrigerator and avoid introducing warm food or steaming liquids.
- Only leave the door open for the strict amount of time necessary to introduce or remove food

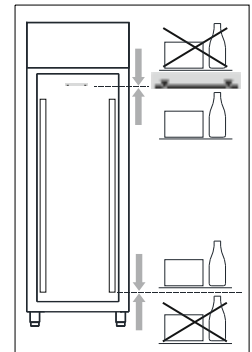

**WARNING:** If ambient conditions do not allow the evaporation of condense water through the automatic system, insert container on the external bottom part or convey water toward sewerage.

## STOPPING

Press this key  for 3 seconds and release it as the display shows the [Sby] to set the appliance to the stand-by mode.

**WARNING:** the main switch  DOES NOT insulate the machine from the electric current.

Set the general cut-out in OFF position.

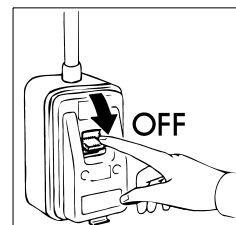

To insulate the refrigerator from the electric current, remove the plug from the socket.

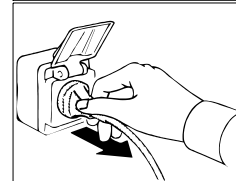

## WORKING IRREGULARITIES

In case of working irregularities, before to call the technical service in zone verify that:

- the control board is turned on and the current is present;
- the regulated temperature is the wished one;
- the doors are perfectly closed;
- the machine is not near heat sources;
- the condenser is clean and the fan works regularly;
- an excess of hoarfrost does not cover the evaporating pannel.

In case of negative result, contact the nearest service centre indicating the model (1) and the serial number (5) shown on the rating placed on the appliance instrument panel.

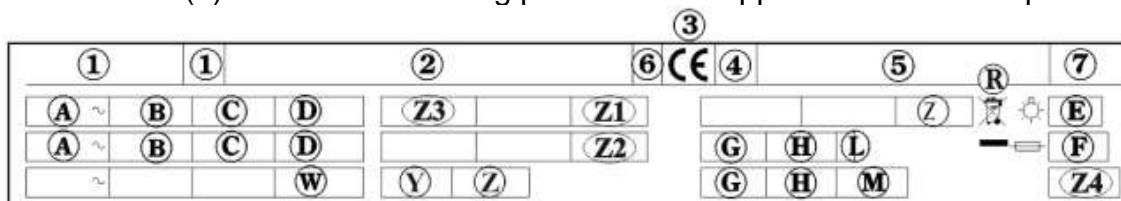

## FOOD STAINS AND HARDENED RESIDUES

In case there are food or waste stains in the fridge, wash the surfaces with water and clean them off before they might harden.

If the wastes have already hardened, please follow the instructions hereunder:

1. Use a soft sponge drenched with lukewarm water and neutral detergent (you can use the detergents for the daily cleaning operations, at the highest concentration estimated by the label).



2. Dampen the hardened waste so as to maintain it damp for at least 30 minutes passing on it every five minutes the sponge drenched with water and detergents on the hardened dirty area.
3. At the end of this soaking operation remove the waste with the sponge drenched with water and neutral detergents.
4. If needed, use a wooden spatula or a fine stainless-steel sponge, taking care of not damaging the fridge surface.
5. At the end of this process it is recommended a daily cleaning operation cycle of all the internal surfaces of the fridge.
6. When the cleaning operations are over, rinse carefully with a sponge drenched with running water.
7. Dry carefully using a clean sponge.

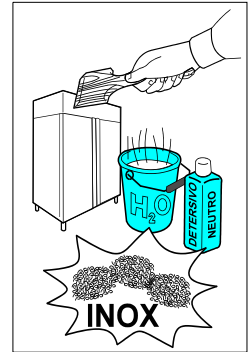

The space around and under the refrigerator must also be cleaned and held in perfect hygiene.  
Clean using water and neutral soap or detergent.

Protect the sheet metal parts with silicon wax.

## USEFULL ADVICES FOR THE CARE OF THE STAINLESS STEEL

The refrigerators are built with STAINLESS STEEL AISI 304.

For the cleaning and maintenance of the parts of stainless steel follow the advices written below, bearing in mind that the first and fundamental rule is to guarantee the non toxicity and best hygiene of the dealed products.

The stainless steel has a thin oxide coat that prevents rust formation. But there are substances or detergents that can destroy this coat and give origin to corrosions. Before using any detergent product ask always your dealer about which neutral detergent is the most qualified and does not cause corrosions on the steel.

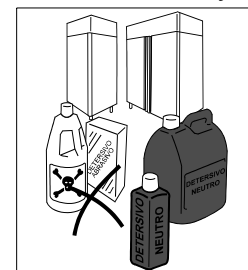

In case of scratches on the surfaces it is necessary to smooth them using thin STAINLESS STEEL wool or an abrasive sponge in synthetic fibrous material, wiping in the direction of the satin.

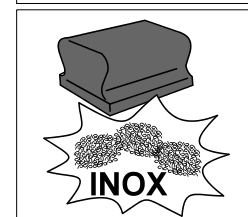

**WARNING:** for the cleaning of the STAINLESS STEEL never use iron wool and never let them rest on the surfaces because little iron deposits could remain on the surfaces and cause rust formations by contamination and endanger the hygiene.

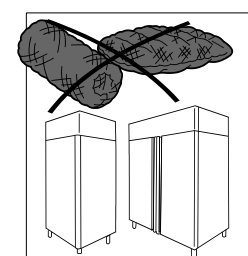

## USAGE INTERRUPTIONS

In case of longer inactivity of the refrigerator and for maintaining it in the best state act as following:

- set the general cut-out in OFF position.
- remove the plug from the socket.

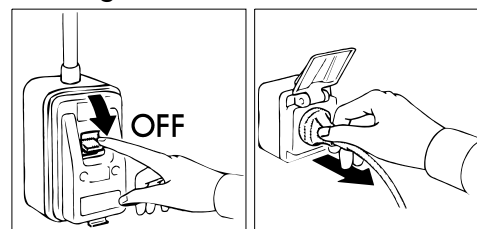

- empty the refrigerator and clean it as described In the chapter "CLEANING".

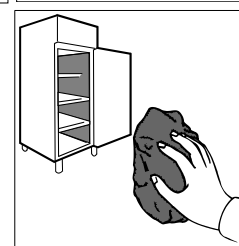

- let the doors open to avoid the forming of bad smell.
- cover compressor set with a nylon sheet to protect it from dust.

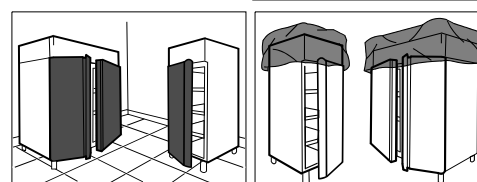

## MALFUNCTIONING

Malfunctioning during operation is often due to banal causes , which may nearly all be resolved without the help of a specialised technician. Consequently, before getting in touch with a service centre, check the following:

PROBLEM	POSSIBLE CAUSES
The appliance does not start	Check that the plug is properly inserted into the socket.
	Check that there is voltage at the socket
The internal temperature is too high	Check the electronic card adjustment
	Check for a heat source in the vicinity
	Check that the door closes properly
The appliance is excessively noisy	Check that the appliance is standing level. A lopsided appliance could set off vibrations
	Check that the appliance is not touching other appliances or parts which could resonate
There are unpleasant smells inside the refrigerator	There are foodstuffs with a particularly strong smell (for example cheese and melon), placed in non-sealed containers
	Internal surfaces must be cleaned
Some condensation is produced on the appliance	Room humidity is very high
	Doors are not well-closed
Bulb not operational	Replace the bulb by interrupting the power supply of the appliance

Upon completion of the above checks, if the fault persists, contact an authorised service centre. Always indicate:

- the nature of the fault

- the model and the serial number that can be found on the technical feature plate, placed under the appliance instrument panel.

## INVERTING THE DOOR

Refrigerator cabinets are normally supplied with opening to the right. To invert the door (hinge on the left side) follow this procedure:

- Undo the screw “F” under the dashboard.
- Unhook the dashboard, pulling it forward  
In model. *“Ice cream – Pastry & Bakery”* rotate the instrument panel on the side heads by removing the “F” screw.
- Remove the two fixing screws of the bracket “A” and the holding screw of the hinge “B”.
- Extract the door, remove the hinge “B” and the component “e” and invert their position.
- Remove the lower bracket “d” and install it in its housing on the opposite side.
- Place the door by introducing the hole of the lower component “E” into the pin of the bracket “D”.
- Fix the bracket “A” to the structure on the opposite side by tightening the fixing screws.
- Before tightening the bracket screws, check the hinge height (12 mm approx.) and the door perpendicular position with respect to the structure.
- Replace the instrument panel.

**NOTE:** Keep the door closed when removing and installing the brackets.

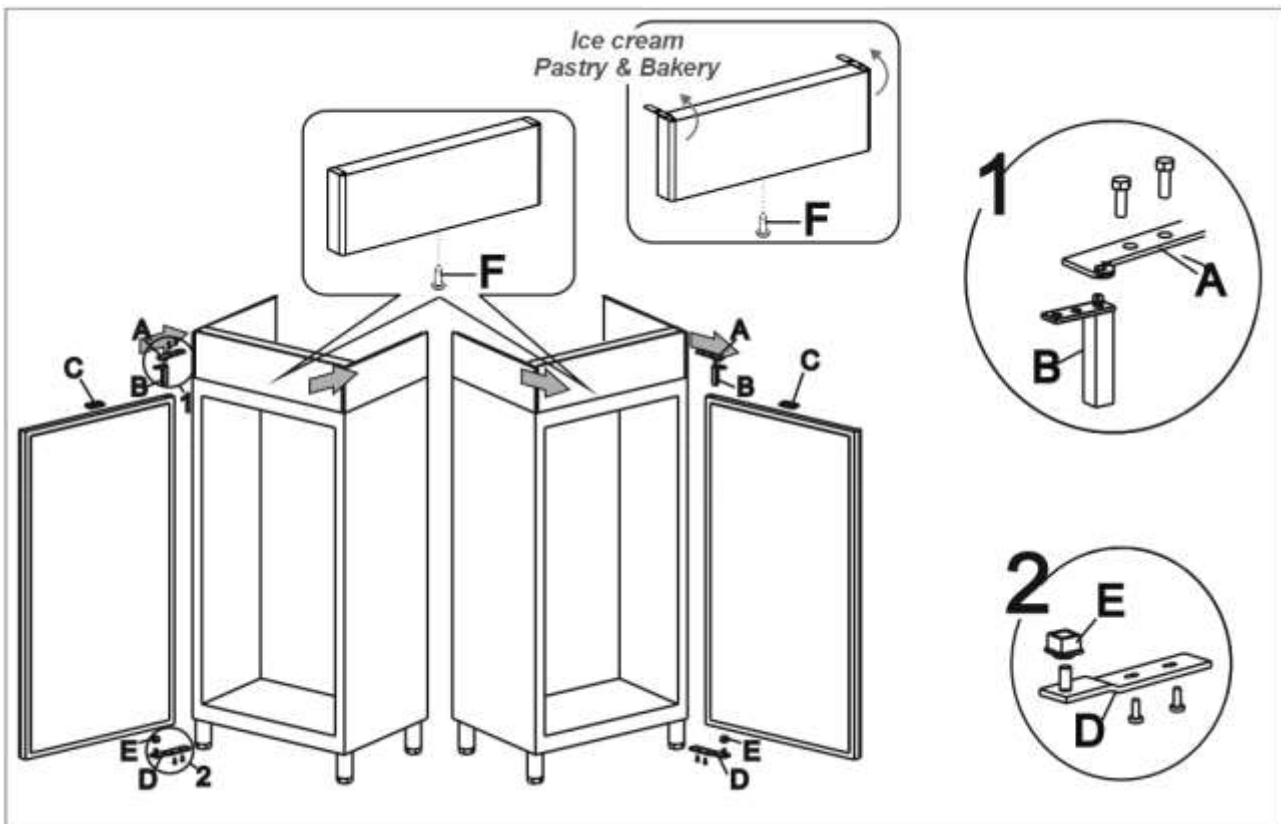

## INVERTING THE PANEL COLD STORE DOOR

Panel cold stores are supplied with doors opening to the right.

To rehing to the left, follow the steps below:

- Rotate the instrument panel on the side heads removing the lower side screws.
- Remove the door from hinges **A** while pulling upward.
- Remove the two hinges **A** by means of a suitable tool.
- Reinstall the two hinges **A** onto the opposite side using the prearranged holes.
- Remove gasket **C** and adapt it on the opposite side of the door.
- Rotate the door hinges **B** on their axis.
- Replace the door on hinges **A**.
- Move the micro located on the control panel to the opposite side, using the prearranged holes.
- Replace the instrument panel inserting the screws.

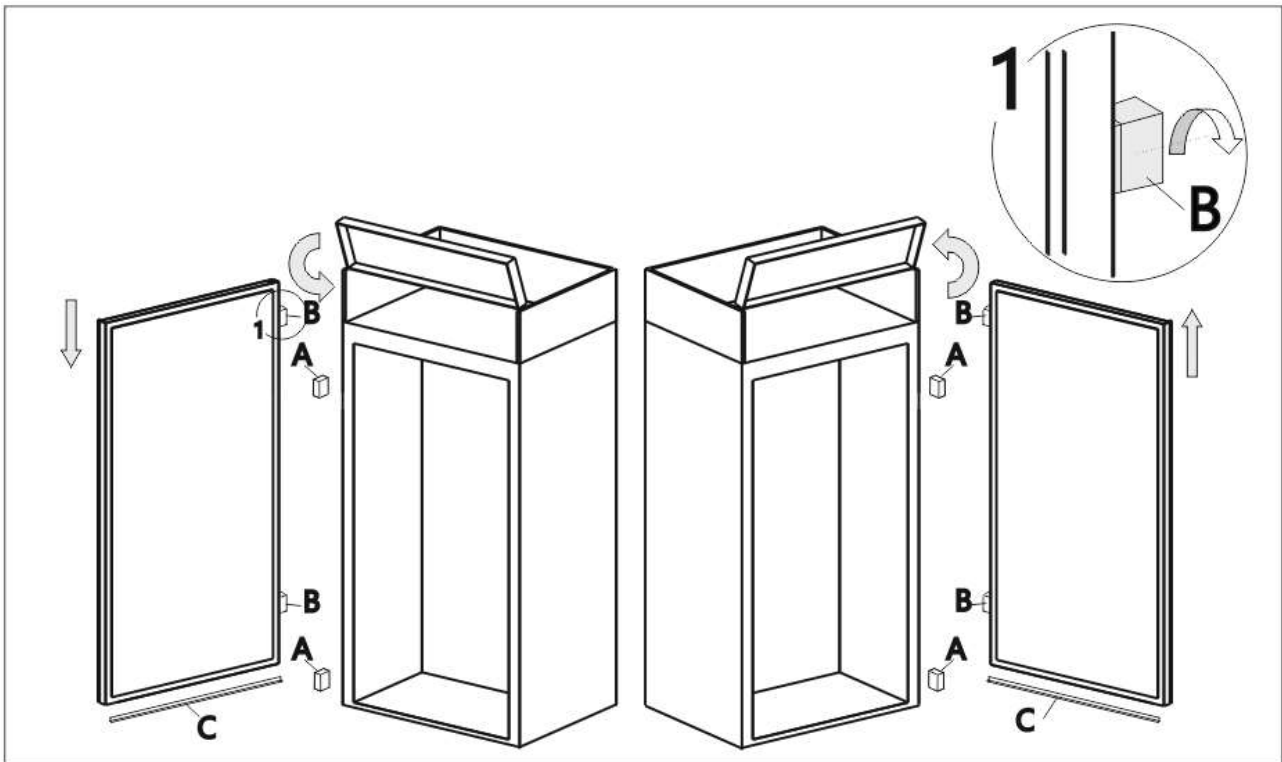

## REFRIGERANT MATERIAL SAFETY DATA SHEET

### 1) R134a

GWP = 1300

ODP = 0

### R404A: fluid components

- trifluoroethane (HFC 143a) 52%
- pentafluoroethane (HFC 125) 44%
- tetrafluoroethane (HFC 134a) 4%

GWP = 3922

ODP = 0

❖ Hazard identification

Overexposure through inhalation may cause anaesthetic effects. Acute overexposure may cause cardiac rhythm disorders and sudden death. Product mists or sprays may cause ice burns of eyes and skin.

❖ First aid procedures

• *Inhalation:*

keep injured person away from exposure, warm and relaxed. Use oxygen, if necessary. Give artificial respiration if respiration has stopped or is about to stop. In case of cardiac arrest give external cardiac massage. Seek immediate medical attention.

• *Skin:*

use water to remove ice from affected areas. Remove contaminated clothes.

*CAUTION:* clothes may adhere to skin in case of ice burns.

In case of contact with skin, wash with copious quantities of lukewarm water. In case of symptoms (irritation or blisters) seek medical attention.

• *Eyes:*

immediately wash with ocular solution or fresh water, keeping eyelids open for at least 10 minutes. Seek medical attention.

• *Ingestion:*

it can cause vomit.. If conscious, rinse mouth with water and drink 200-300 ml of water. Seek medical attention.

• *Other medical treatment:*

symptomatic treatment and support therapy when indicated. Do not administer adrenaline or sympathicomimetic drugs after exposure, due to the risk of arrhythmia and possible cardiac arrest.

❖ Environmental data

*Persistence and degradation*

• *HFC 143a:*

slow decomposition in lower atmosphere (troposphere). Duration in atmosphere is 55 years.

• *HFC 125:*

slow decomposition in lower atmosphere (troposphere). Duration in atmosphere is 40 years.

• *HFC 134a:*

si decompone con relativa rapidità nell'atmosfera inferiore (troposfera). La durata nell'atmosfera è 15,6 anni.

• *HFCs 143a, 125, 134a:*

does not affect photochemical smog (not included in volatile organic components – VOC – as established in the UNECE agreement). Does not cause ozone rarefaction. Product exhausts released in the atmosphere do not cause long-term water contamination.

**2) R600a o R290**

GWP = 3

ODP = 0

❖ Hazards identification

Liquefied gas - Extremely flammable

❖ First aid measures

• *Inhalation:*

In high concentrations may cause asphyxiation. Symptoms may include loss of mobility and/or consciousness. Victims may not be aware of asphyxiation. In low concentrations, may cause narcotic effects. Symptoms may include dizziness, headache, nausea and loss of coordination. Remove victim to an uncontaminated area wearing self contained breathing apparatus. Keep the patient relaxed and warm. Call a physician. Apply artificial respiration if breathing stops..

• *Contact with skin and eyes:*

In case of spillage, rinse thoroughly with water for at least 15 minutes

• *Ingestion:*

Route of exposure unlikely

❖ Informazioni ecologiche

Ecological information No known ecological damage caused by this product

## WIRING DIAGRAM

The electrical diagram is shown on the last page of the booklet.

Pos	DESCRIPTION	Pos	DESCRIZIONE
1	COMPRESSOR UNIT	30A	STARTER
2	COMPRESSOR FAN	31	TL LAMP
3	GENERAL TERMINAL BOARD	31A	TL LAMP
6	MAIN SWITCH WITH PILOT	42	COMPRESSOR AIR EXTRACTION VENTILATOR
8	PLUG	44	RELAY COMPRESSOR
9	EVAPORATOR FUN	44A	RELAY DEFROST
9A	EVAPORATOR FUN	44B	RELAY MAGNETIC MICRO-SVWITCH
9B	EVAPORATOR FUN	56	FILTER
10	INTERNAL LIGHTING LAMP	69	GROUNDING TERMINAL
10A	INTERNAL LIGHTING LAMP	75	SOLENOID VALVE
12	SOLENOID VALVE DEFROSTING	76	MAGNETIC DOOR MICRO SWITCH
19	BOWL RESISTANCE THERMOSTAT	85	CONNECTION BOX
20	DOOR ANTICONDENSING RESISTOR	86	CONDENSER PROBE
20A	DOOR ANTICONDENSING RESISTOR	101	BUFFER RESISTANCE
21	TRY BOTTOM RESISTOR	102	BIMETALLIC SAFETY THERMOSTAT
22	RESISTANCE FOUND BASIN	113	MICROSWITCH 4 CONTACTS
29	TL LAMPS BALLAST	113A	MICROSWITCH 4 CONTACTS
29A	TL LAMPS BALLAST	114	LED ELECTRONIC CARD - REFRIGERATOR
30	STARTER		