

**ABBATTITORI/SURGELATORI DI TEMPERATURA
CELLULES DE REFROIDISSEMENT RAPIDE/CELLULES MIXTES
SCHNELLKÜHLER/SCHOCKFROSTER
BLAST CHILLERS/FREEZERS
ABATIDORES/CONGELADORES RAPIDOS DE TEMPERATURA
AFKOEL/VRIESKAST
ABATEDORES/CONGELADORES RÁPIDOS DA TEMPERATURA
БЫСТРЫЕ ОХЛАДИТЕЛИ/МОРОЗИЛЬНИКИ**

**MANUALE D'USO E INSTALLAZIONE
MANUEL D'UTILISATION ET D'INSTALLATION
BEDIEN- UND INSTALLATIONSHANDBUCH
USE AND INSTALLATION MANUAL
MANUAL DE USO E INSTALACIÓN
GEBRUIKS- EN INSTALLATIEHANDLEIDING
MANUAL DE USO E INSTALAÇÃO
РУКОВОДСТВО ПО ЭКСПЛУАТАЦИИ И УСТАНОВКЕ**



IT

Leggere attentamente le avvertenze contenute nel presente libretto in quanto forniscono importanti indicazioni riguardanti la sicurezza, d'uso e di manutenzione.

Conservare con cura questo libretto per ogni ulteriore consultazione dei vari operatori.

Il costruttore si riserva il diritto di apportare modifiche al presente manuale, senza preavviso e responsabilità alcuna.

FR

Lire avec attention les instructions contenues dans ce livret car elles fournissent d'importants renseignements pour ce qui concerne la sécurité, l'emploi et l'entretien.

Garder avec soin ce livret pour des consultations ultérieures de différents opérateurs.

Le constructeur se réserve le droit d'apporter des modifications à ce manuel, sans préavis ni responsabilité d'aucune sorte.

DE

Lesen Sie bitte aufmerksam diese Gebrauchsanweisung durch, die wichtige Informationen bezüglich der Sicherheit, dem Gebrauch und der Instandhaltung enthält.

Heben Sie sorgfältig diese Gebrauchsanweisung auf, damit verschiedene Anwender sie zu Rat ziehen können.

Der Hersteller behält sich das Recht, Änderungen dieser Gebrauchsanweisung ohne Ankündigung und ohne Übernahme der Verantwortung vornehmen zu können.

GB

Carefully read the instructions contained in the handbook. You may find important safety instructions and recommendations for use and maintenance.

Please retain the handbook for future reference.

The Manufacturer is not liable for any changes to this handbook, which may be altered without prior notice.

ES

Lea atentamente las advertencias contenidas en este manual pues dan importantes indicaciones concernientes la seguridad, la utilización y el mantenimiento del aparato.

Rogamos guarde el folleto de instalación y utilización, para eventuales futuros usuarios.

El constructor se reserva el derecho de hacer modificaciones al actual manual, sin dar algún preaviso y sin responsabilidad alguna.

NL

Nauwkeurig de waarschuwingen in dit boekje lezen, aangezien zij belangrijke aanwijzingen verschaffen wat betreft de veiligheid, het gebruik en het onderhoud.

Dit boekje goed bewaren.

De fabrikant behoudt zich het recht voor om veranderingen in deze handleiding aan te brengen, zonder voorafgaande waarschuwing en zonder enkele aansprakelijkheid.

P

Leia com atenção as advertências contidas neste manual pois fornecem importantes indicações para a segurança, a utilização e a manutenção do aparelho.

O construtor reserva-se o direito de modificar o manual sem dar aviso prévio e sem nenhuma responsabilidade.

RU

Внимательно читайте предупреждения, содержащиеся в настоящем руководстве, касающиеся надежности использования и обслуживания.

Конструктор сохраняет за собой право вносить изменения в настоящее руководство без предупреждения и любой ответственности.

INDEX

GENERAL INSTRUCTIONS ON DELIVERY.....	5
GENERAL WARNINGS	5
LIST OF REGULATION REFERENCES.....	5
TRANSPORTATION AND HANDLING	5
UNPACKING	5
GENERAL SAFETY WARNINGS	6
INSTALLATION	7
PLATE DATA.....	7
MAX ROOM TEMPERATURE	7
POSITIONING	8
DIMENSIONS	9
TECHNICAL DATA.....	11
WIRING.....	12
CONDENSATE DRAIN	12
TESTING.....	13
CONTROL AND SAFETY SYSTEMS	13
REFRIGERANT MATERIAL SAFETY DATA SHEET	13
DISPOSAL.....	14
STERILIZATION LAMP INSTALLATION	15
PRINTER INSTALLATION.....	15
OPERATION	16
GENERAL DESCRIPTION	16
SETTING UP	16
MACHINE LOADING.....	17
POSITION OF TRAYS.....	17
CORE PROBE	17
TEMPERATURES	18
LENGTH	18
CONTROL PANEL	19
FIRST START-UP	20
PROGRAMME	21
PROGRAMME DESCRIPTIONS.....	21
STANDARD PROGRAMMES	23
PROGRAMME I.F.R.	24
PROGRAMME INFINITY	25
FAVOURITE PROGRAMMES.....	26
AUTOMATIC PROGRAMMES	27
STORED PROGRAMMES	29
MULTY	31
COOLING	32
FUNCTIONS.....	33
DEFROST	33
SANITATION.....	34
STORAGE	35
THAWING	36
PROVING	38
PROBE HEATING	40
** VIEW / EDIT PARAMETERS CYCLE.....	42
HACCP	43

SETTINGS	52
LANGUAGE	52
SET DATE/CLOCK	53
SECTOR	54
MULTY	55
CYCLE CONTROL - AUTO OR MANUAL	56
SERVICE	57
ALARMS	57
ALARMS TABLE	58
RESET ALLARMI	59
INPUTS OUTPUTS	60
RESTORE	61
PARAMETERS.....	62
 MAINTENANCE	 63
MAINTENANCE AND CLEANING	63
CLEANING THE CABINET.....	63
CLEANING THE AIR CONDENSER	64
STAINLESS-STEEL MAINTENANCE.....	64
DISCONTINUED USE	65
EXTRAORDINARY MAINTENANCE	65
VIDEO BOARD AND ENCODER MAINTENANCE CHECKLIST	65
MAINTENANCE OF PANEL BOARD.....	66
UPDATING THE FIRMWARE (SOFTWARE) OF THE ELECTRONIC CIRCUIT BOARDS.....	68
CONDENSING SYSTEM MAINTENANCE	69
REPLACEMENT CORE PROBE	69
ENERGY CONSUMPTION CHART	70
WIRING DIAGRAM PLATE	71

Annotate the emergency assistance number of specialised maintenance personnel.

Name and Surname	Address	Tel./fax no.

GENERAL INSTRUCTIONS ON DELIVERY

GENERAL WARNINGS

We assure you have made the best choice in purchasing our products and hope you will be fully satisfied with our their performance. To this purpose, we recommend you strictly comply with the instructions and regulations contained in this handbook..

The user is required to carefully read the manual, always referring to it and conserving it in a known place, accessible to all authorised operators.

The equipment is destined only for the function for which it was designed and, being for professional use, must be used only by qualified personnel.

The manufacturer declines all responsibility and any obligation to warranty if damage occurs to the equipment, persons or things, imputable to incorrect installation, inappropriate use by untrained personnel, non specific modifications or interventions, use of non original or non specific replacement parts, failure to observe, even partially, the indications found in this manual.

Please remember that no reproductions of this handbook are allowed. Due to our constant technological updating and research, the features described in this handbook may be altered without prior notice.

LIST OF REGULATION REFERENCES

The cooling cabinet we manufacture fully complies with the following European and national regulations:

2006/42 (machine regulations)
2006/95 (low-voltage regulation)
2004/108 (EMC regulation)
97/23 (PED regulation)
93/68 (new approach regulation)
2002/95 (RoHS regulation)
2002/96 (RAEE regulation)
658/88 CEE
108/89 CEE
DPR 327/80 art.31 (Italy)

D.M. 15-06-71 (Italy)
D.L. n°110 27-01-92 (Italy)
J.O. 16-07-74 n°74-163 (France)

and the following European regulations:

EN55014-1;EN55104-2
EN61000-3-2 ; EN61000-3-3
EN60335-1;EN60335-2-89
EN378-I-II

TRASPORTATION AND HANDLING

For transportation and handling, all precautions necessary must be taken in order not to damage the equipment, referring to the indications found on the packaging of the same.

Make sure that the consignment has not been tampered with or damaged during transport.

UNPACKING

Installation must be carried out by authorised and specialised personnel.

After removing the packaging, ensure the integrity of the equipment and verify that all the parts or components are present and that the characteristics and state correspond to the specifications of the your order.

If not, please inform the retailer immediately.

Remove pvc protective film from all over the appliance.

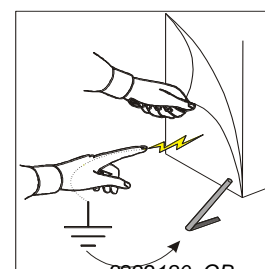
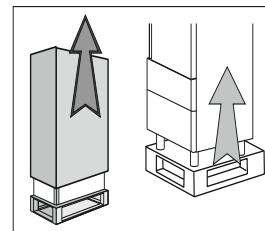

Attention: all the packing material must be disposed of in accordance with the prevailing regulations in the country where the equipment is used and in any case must not be dispersed into the environment.

GENERAL SAFETY WARNINGS

The user is responsible for operations carried out on the equipment which do not comply with the indications in this manual, and periodic training of all personnel authorised to work on the equipment is recommended.

List of some general warnings:

- do not touch the equipment with moist or wet hands or feet
- do not insert screwdrivers or kitchen tools or anything else between the guards and the parts in motion
- before any cleaning or maintenance operation, disconnect the equipment from the electrical mains
- do not pull on the power cord to disconnect the machine from the electrical mains
- during loading/unloading of product in the equipment use kitchen gloves
- use the needle probe to read the temperature at the core of the product, making sure to handle it with care

INSTALLATION

PLATE DATA

Make sure the technical wiring specifications comply with the ratings (i.e., V, kW, Hz, no. phases and mains power).

Please quote the product's serial number (shown on the rating plate) on any enquiry to the Manufacturer.

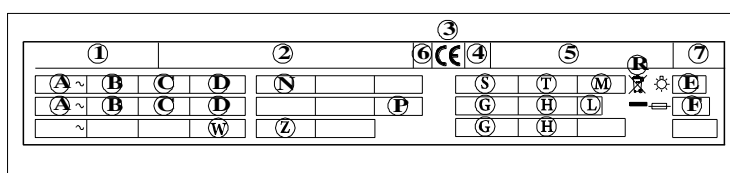

List of rates shown on the rating plate:

- | | |
|-----------------------------------------------|----------------------------------|
| 1) Model | F) Fuse current |
| 2) Manufacturer's name and address | G) Coolant type |
| 3) CE mark | H) Coolant q.ty |
| 4) Year of make | L) Temperature grade |
| 5) Serial number | M) Max hydraulic supply pressure |
| 6) Power insulation class | N) Room temperature |
| 7) Electrical device casing protection rating | P) Expanding fluid |
| A) Input voltage | R) WEEE Symbol |
| B) Electric current intensity | S) Water inlet temperature a |
| C) Frequency | T) Water consumption |
| D) Rated power | W) Heating unit power |
| E) Total lamp power | Z) Least pressure |

MAX ROOM TEMPERATURE

Air-condenser units should not operate if room temperature is over 38°C. Above 32°C maximum output is not guaranteed.

The remote condensers must be installed outdoors out of direct sunlight or in suitable rooms. Always make sure that air ventilation is present. Check that suitable covers are used.

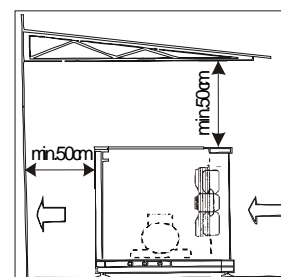

Min. air circulation

Model	Air q.ty [m ³ /h]
10 kg	1.100
20 kg	3.500
72 kg	9.000
144 kg	13.500

POSITIONING

The appliance must be installed and tested in full compliance with accident-prevention regulations contained in national law and current guidelines. Installers are to comply with any current local regulations.

- Place the appliance onto the required working site.

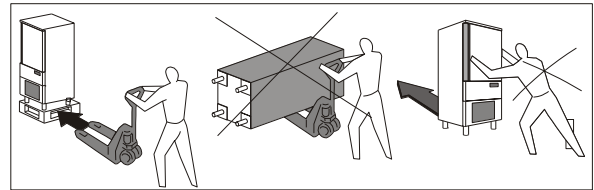

- Avoid locations with exposure to direct sunlight.
- Do not place the appliance in hot, poorly-ventilated rooms.
- Do not place the refrigerated compartment near heat sources.

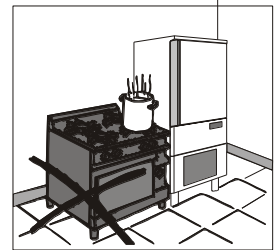

- Leave a min. 100-mm clearance around the appliance on the sides where air inlet and outlet are located.

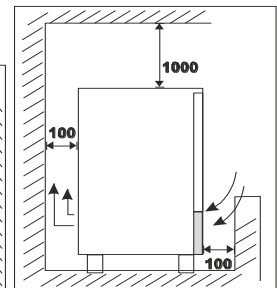
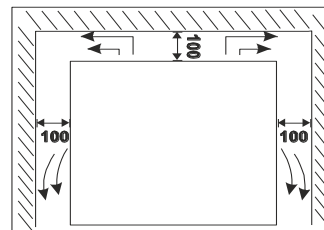

- Level the appliance by means of adjustable feet.

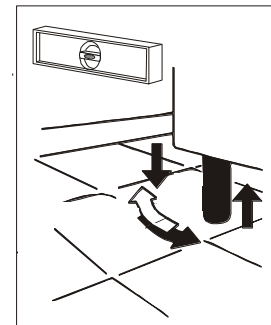

- In case of 72 kg and 144 kg blast chillers, set the handle moving the washers before or after the P plate.
- Use suitable fork lift trucks to level heavier appliances (20-kg models onwards)

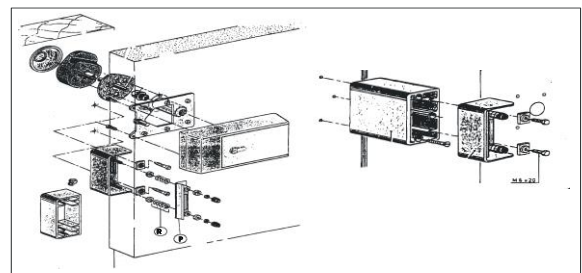

WARNING: If the appliance is not properly levelled the performance and condensate drain may be hampered.

DIMENSIONS

Please refer to the dimensions of your own appliance.

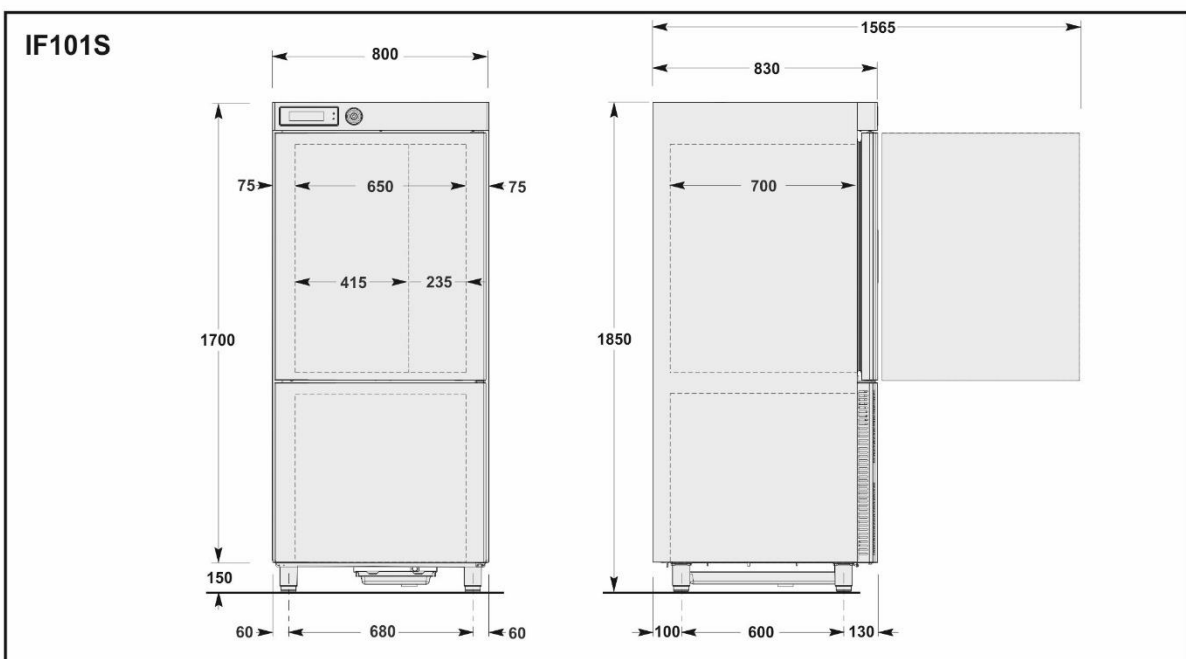
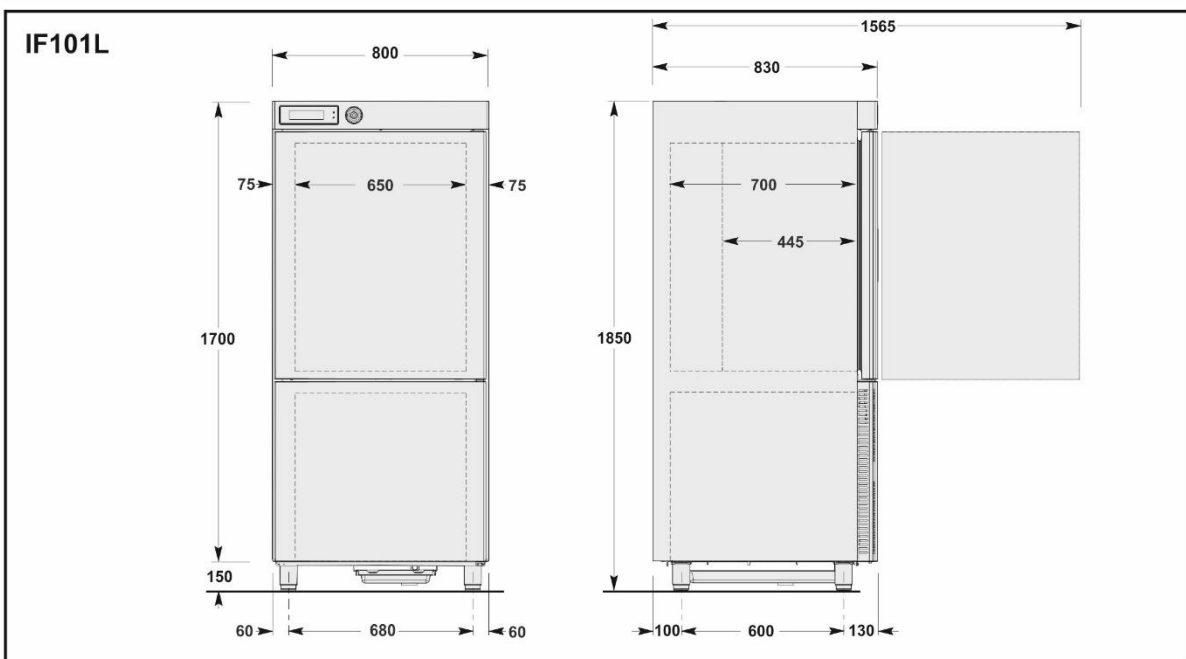
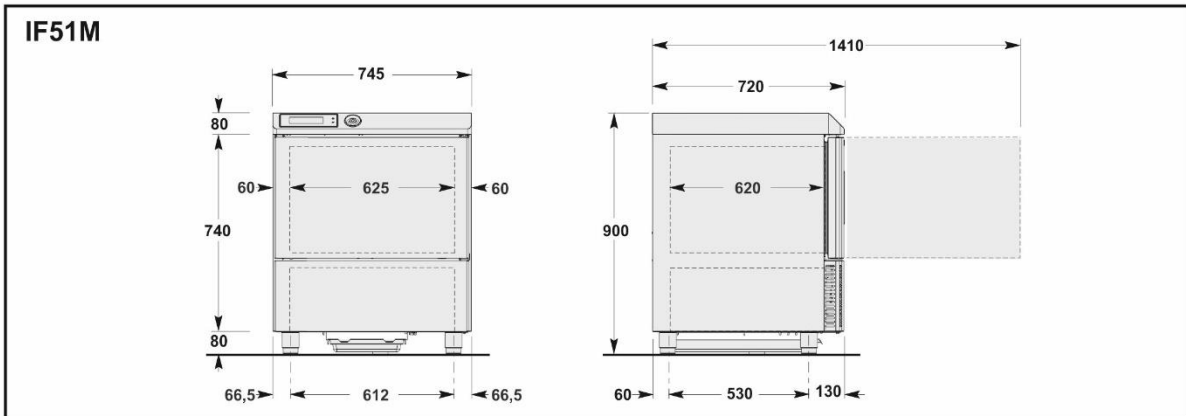

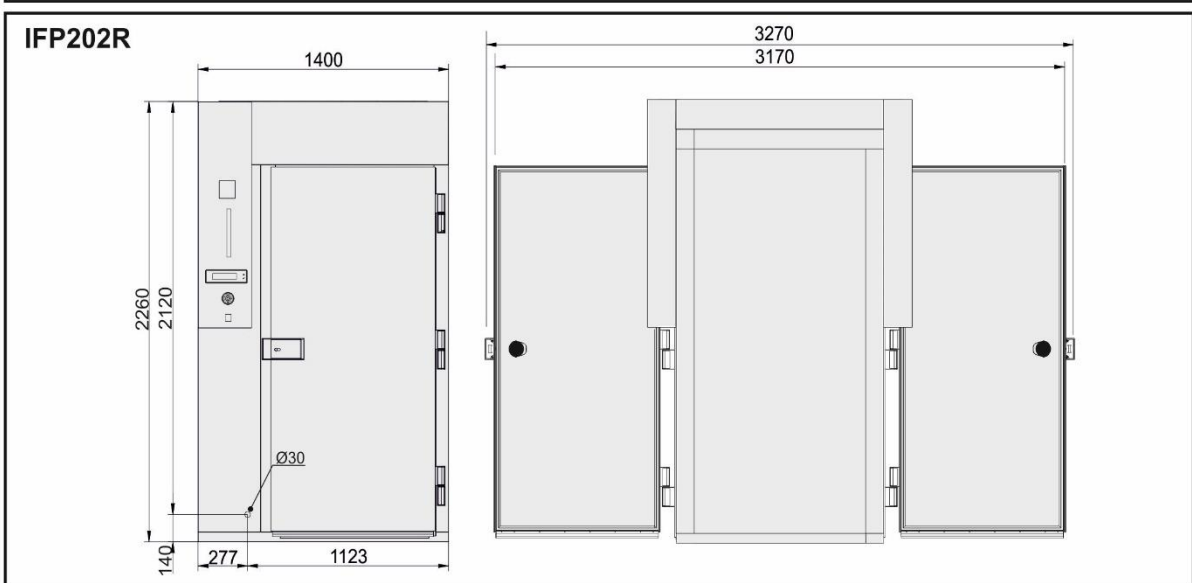
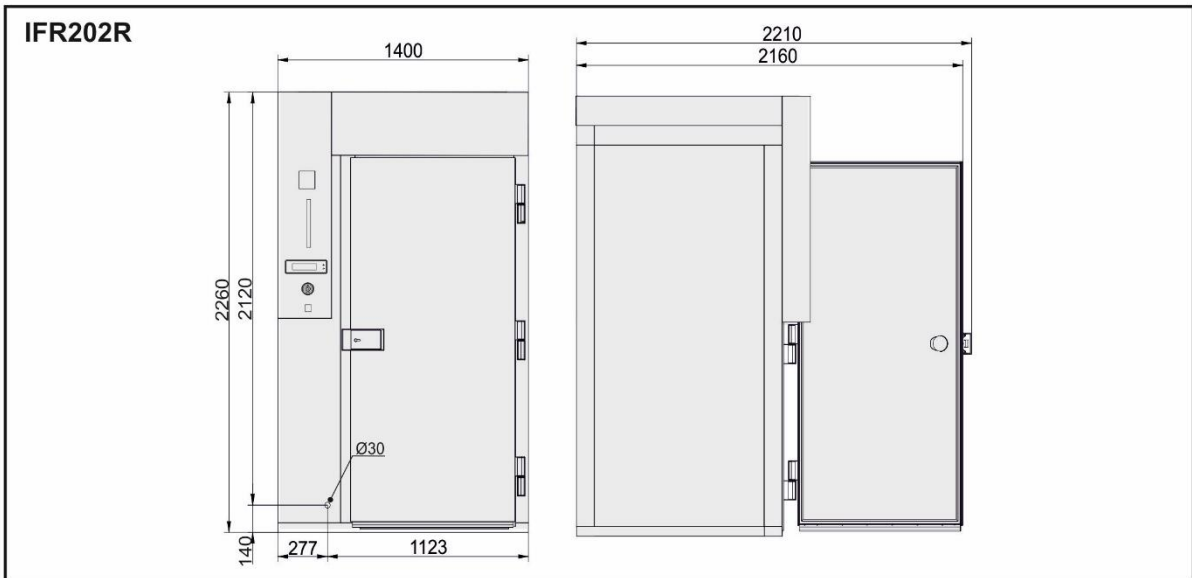
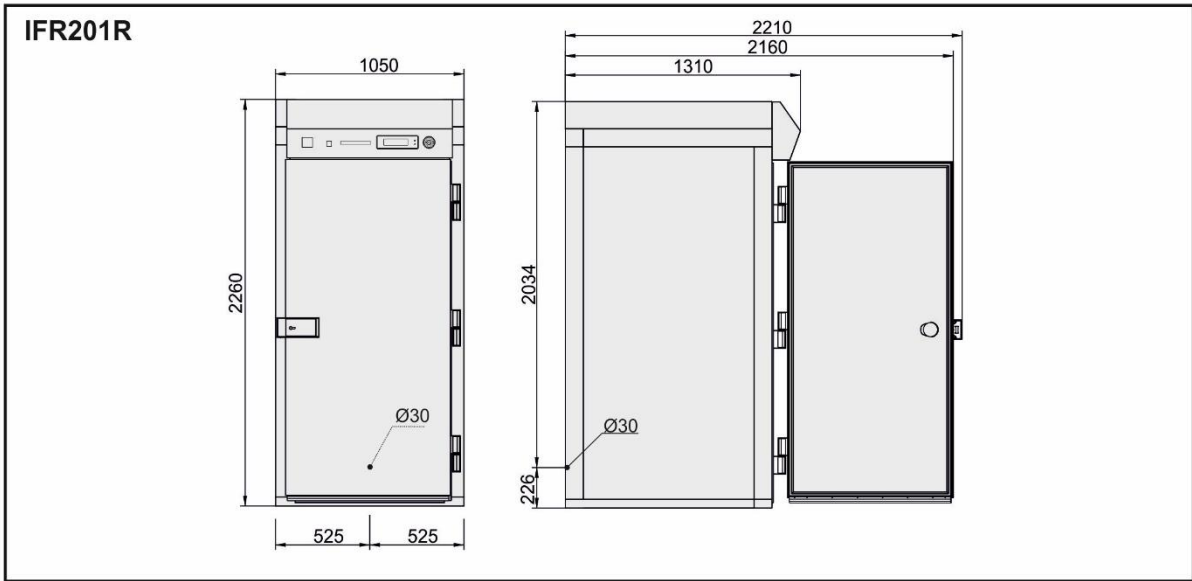

TECHNICAL DATA

Please refer to the technical data of your own appliance.

Model	IF51M (10Kg)	IF101L (20Kg L)	IF101S (20Kg S)	IFR201R (72Kg)	IFR202R IFP202R (144Kg)
Gross weight	130	225	225	380	500
Net weight	120	200	200	280	360
Dimensions	745x720x900	800x830x1850	800x830x1850	1050x1310x2260	1400x1310x2260 1400x1470x2260
Capacity					
Mass /cycle [kg] (+70°C ÷ +3°C)	22	45	45	120	210
Mass /cycle [kg] (+70°C ÷ -18°C)	13	27	27	72	144
Internal volume [l]	90	195	195	1900	2800
Rails	GN1/1 600x400	GN1/1 600x400	GN1/1 600x400	GN1/1 600x400	GN2/1 600x400
Trays	5	10	10	20	20
Power supply					
Voltage [V]	230V 1N~	400V 3N~	400V 3N~	400V 3N~	400V 3N~
Frequency [Hz]	50	50	50	50	50
Intensity [A]	6,9	6,5	6,5	4	5,5
Power input [W]	1400	4000	4000	900 [3600]	1200 [5300]
Refrigerating unit					
Refrigerating power [W]	1054	3136	3136	5070	9710
Evaporation temperature [°C]	-23,3	-23,3	-23,3	-23,3	-23,3
Cooling temperature [°C]	+90÷+3	+90÷+3	+90÷+3	+90÷+3	+90÷+3
Cooling time [min]	90	90	90	90	90
Freezing temperature [°C]	+90÷-18	+90÷-18	+90÷-18	+90÷-18	+90÷-18
Freezing time [min]	240	240	240	240	240
Condensation temperature [°C]	+54,5	+54,5	+54,5	+54,5	+54,5
Max room temperature [°C]	+32	+32	+32	+32	+32
Compressor type	Ermetic	Ermetic	Ermetic	Ermetic	Ermetic
Coolant	R404A/R452A	R404A/R452A	R404A/R452A	R404A/R452A	R404A/R452A
Coolant qty [g]	1400	2000	2000	1000	2000
Condesation air	Air	Air	Air	Air	Air
Noise [dB] (A)	65	72	72	72	72
IFR	•	•	•	•	•
Multi-detector probe	•	•	•	•	•

WIRING

An omnipolar switch is to be installed before the appliance, in compliance with the current regulations applied in the country where the appliance is installed.

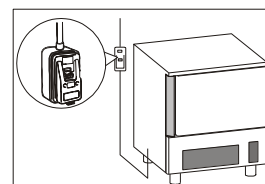

The electrical connection is carried out from the rear part.

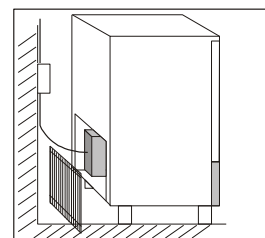

In models with distance condenser the cabinet and the unit (**pict.32**) must be connected separately.

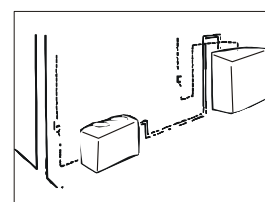

To complete the connection between the unit and the condensing unit access the box interconnect positioned on the sky and open the lateral panel of the electrical board (**pict.33**) in the condenser.

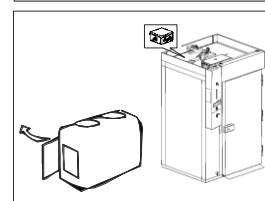

The electrical mains cables must be correctly sized and selected based on the installation conditions.

The 10kg models have 3m of single phase cable (3G 1,5mm²) with a SCHUKO type plug.
The 20kg-72kg-144kg models have 3,5m of three-phase cable (5G 2,5mm²) without plug.

The grounding cable is to be directly connected to a good grounding system.

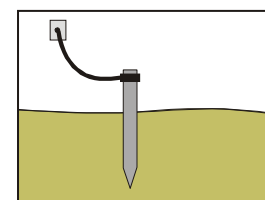

The guarantee will cease and the Manufacturer will not be liable for any damage to appliances or operators arising from the non-compliance with the and tamperings to any part of the appliance (electric, thermodynamic or hydraulic plant).

CONDENSATE DRAIN

Mod. 10 - 20kg

The equipment has a condensation collection tray. The tray is extractable from the lower part of the equipment.

Mod. 72 - 144kg

For these models, a condensation discharge \varnothing 21mm hose installation is necessary, ("IMQ 3321" or any similar type). The current general and local regulations as to drains are to be complied with.

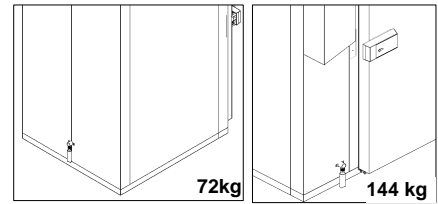

TESTING

Should the appliance have been transported horizontally instead of a vertical position DO NOT START THE APPLIANCE IMMEDIATELY. WAIT FOR AT LEAST **24 HOURS** BEFORE OPERATING.

The manufacturer declines any responsibility and any warranty obligation if damage occurs to the equipment imputable to transportation in a horizontal position.

Carry out the following checkings:

- 1) Outside temperatures must be included between 15°C and 38°C.
- 2) Turn on the appliance and wait 30 minutes before the use if the external temperature is "low".
- 3) Check power input
- 4) Carry out at least one full quick cooling cycle

CONTROL AND SAFETY SYSTEMS

The following information concerns skilled staff only.

- **Door micro-switch:** Prevents the appliance from working when the door is open
- **Overall protection fuses:** Protect the whole power circuit from and short-circuits and overloads
- **Compressor thermal relay:** Operates in case of an overload or working failures
- **Motor-fan thermal relay:** Operates in case of an overload or working failures
- **Safety pressure-switch:** Operates in case of coolant over-pressure
- **Cabinet temperature control:** Is run by NTC probe through the relevant electronic card
- **Core temperature control:** Is run by PT100 probe through an electronic card
- **Electronic boards:** based on the parameters entered they command and control any devices connected to the equipment.

REFRIGERANT MATERIAL SAFETY DATA SHEET

1) **R404a:** fluid components

- trifluoroethane (HFC 143a) 52%
- pentafluoroethane (HFC 125) 44%
- tetrafluoroethane (HFC 134a) 4%

GWP = 3750

ODP = 0

R452A: fluid components

- pentafluoroethane (HFC 125) 59%
- tetrafluoropropene (HFC 1234yf) 30%
- difluoromethane (HFC 32) 11%

GWP = 2141

ODP = 0

2) **Hazard identification**

Overexposure through inhalation may cause anaesthetic effects. Acute overexposure may cause cardiac rhythm disorders and sudden death. Product mists or sprays may cause ice burns of eyes and skin.

3) **First aid procedures**

- **Inhalation:** keep injured person away from exposure, warm and relaxed. Use oxygen, if necessary. Give artificial respiration if respiration has stopped or is about to stop. In case of cardiac arrest give external cardiac massage. Seek immediate medical attention

- Skin: use water to remove ice from affected areas. Remove contaminated clothes.
CAUTION: clothes may adhere to skin in case of ice burns.
In case of contact with skin, wash with copious quantities of lukewarm water. In case of symptoms (irritation or blisters) seek medical attention.
- Eyes: immediately wash with ocular solution or fresh water, keeping eyelids open for at least 10 minutes. Seek medical attention.
- Ingestion: it can cause vomit. If conscious, rinse mouth with water and drink 200-300 ml of water. Seek medical attention
- Other medical treatment: symptomatic treatment and support therapy when indicated. Do not administer adrenaline or sympatheticomimetic drugs after exposure, due to the risk of arrhythmia and possible cardiac arrest.

4) Environmental data

Persistence and degradation

- *HFC 143a*: slow decomposition in lower atmosphere (troposphere). Duration in atmosphere is 55 years.
 - *HFC 125*: slow decomposition in lower atmosphere (troposphere). Duration in atmosphere is 40 years.
 - *HFC 134a*: relatively rapid decomposition in lower atmosphere (troposphere). Duration in atmosphere is 15.6 years
 - *HFC 143a, 125, 134a*: does not affect photochemical smog (not included in volatile organic components – VOC – as established in the UNECE agreement). Does not cause ozone rarefaction.
- Product exhausts released in the atmosphere do not cause long-term water contamination.

DISPOSAL

WASTE STORAGE

At the end of the product life, avoid release to the environment. The doors should be removed before disposal. Temporary storage of special waste is permitted while waiting for disposal by treatment and/or final collection. Dispose of special waste in accordance with the laws in force with regard to protection of the environment in the country of the user.

PROCEDURE FOR ROUGH DISMANTLING THE APPLIANCE

All countries have different legislation; provision laid down by the laws and the authorised bodies of the countries where the demolition takes place are therefore to be observed. A general rule is to deliver the appliance to specialised collection and demolition centres. Dismantle the refrigerator grouping together the components according to their chemical nature. The compressor contains lubricating oil and refrigerant, which may be recycled. The refrigerator components are considered special waste, which can be assimilated with domestic waste. Make the appliance totally unusable by removing the power cable and any door locking mechanisms in order to avoid the risk of anyone being trapped inside.

DISMANTLING OPERATIONS SHOULD BE CARRIED OUT BY QUALIFIED PERSONNEL.

THE SAFE DISPOSAL OF WASTE FROM ELECTRICAL AND ELECTRONIC EQUIPMENT (WEEE DIRECTIVE 2002/96/EC)

Do not dump pollutant material in the environment. Dispose of it in compliance with the relevant laws.

Under the WEEE (Waste Electrical and Electronic Equipment) Directive 2002/96/EC, when scrapping equipment the user must dispose of it at the specific authorised disposal centres, or reassign it, still installed, to the original seller on purchase of new equipment.

All equipment which must be disposed of in accordance with the WEEE Directive 2002/96/EC is marked with

a special symbol .

The improper disposal of Waste Electrical and Electronic Equipment is liable to punishment under the relevant laws in the countries where the offence is committed.

Waste electrical and Electronic Equipment may contain hazardous substances with potential harmful effects on the environment and human health. You are urged to dispose of them properly.

STERILIZATION LAMP INSTALLATION

The sterilization lamp kit is not supplied as standard equipment.

Should you purchase the kit, please follow the installation instructions to install.

PRINTER INSTALLATION

The printer is not supplied as standard equipment .

Should you purchase the printer, please follow the installation instructions to install.

OPERATION

GENERAL DESCRIPTION

The blast chiller is a chilling machine capable of cooling the temperature of a freshly cooked product up to +3°C (positive chilling) and up to -18°C (negative chilling), in order to conserve it for a long period of time without altering the organoleptic characteristics.

Machine capacity as to the quantity to be cooled depend on the model purchased.

SETTING UP

Before setting to operation thoroughly clean the cooling cabinet with a suitable detergent or sodium bicarb dissolved in lukewarm water. Clean the appliance inside to remove any condensate caused by the Manufacturer's final testing.

Cooling and freezing speed depends on the following factors:

- a) container shape, type and material;
- b) whether container lids are used;
- c) foodstuff features (density, water contents, fat contents);
- d) starting temperature;
- e) thermal conduction inside the foodstuffs.

Positive /Negative quick cooling time depends on type of foodstuffs to be processed.

In general the programmes the machine is equipped with are based on the chamber temperature management, the fan speed and the chilling time, in any case never exceed 3.6kg of load (for GN1/1, EN1/1 or 60x40 pans) or 7.2kg of load (for GN2/1, EN2/1 or 60x80 pans) and a thickness of 50mm in negative chilling phase and 80mm in positive chilling phase (**table 2**).

Check that the positive chilling programme, up to +3°C at the product core, does not take more than 90 minutes and that the negative chilling programme, up to -18°C at the product core, does not take more than 4 hours.

We recommend pre-chilling the work chamber before beginning with a chilling programme and not covering the food during the programme in order not to increase times.

We recommend using the core probe in order to have the exact core temperature reading. Do not stop the cycle before reaching a temperature of +3°C during positive quick cooling and -18°C during negative quick cooling.

Tab.2

Model	Max. output/cycle		Capacity			h
	+70[°C]÷+3[°C]	+70[°C]÷-18[°C]	n° max	GN	EN	
IF51M	22[kg]	13[kg]	5	1/1	600X400	40
IF101L – IF101S	45[kg]	27[kg]	10	1/1	600X400	40
IFR201R	120[kg]	72[kg]	20	1/1	600X400	40
IFR202R-IFP202R	210[kg]	144[kg]	20	2/1	600X800	40

MACHINE LOADING

Do not pile up foodstuffs to be cooled. Thickness should be lower than 50mm in negative quick cooling and lower than 80mm in positive quick cooling.

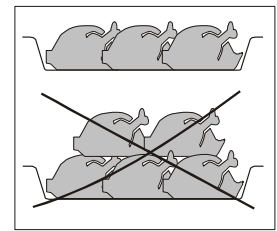

Make sure air circulation is not hampered between food trays.

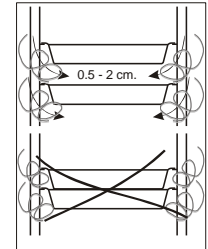

The grid-holding frame (included in those models which include trolleys) is to be located at the centre of the cabinet.

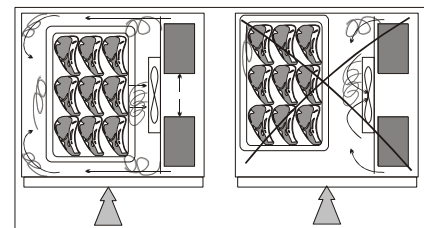

POSITION OF TRAYS

Place the trays as close to the evaporator as possible.

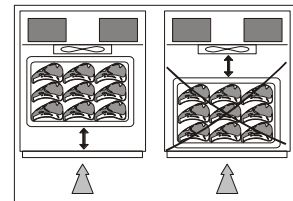

If the cabinet is not full place the trays at equal distance from one another.

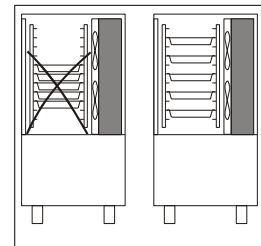

CORE PROBE

For proper position of the probe, refer to the following pictures.

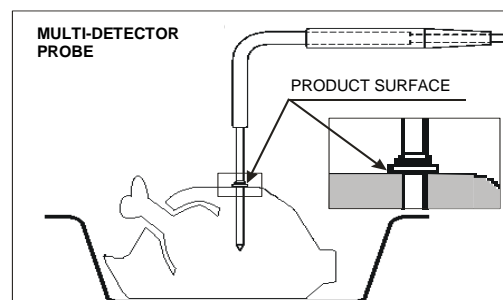
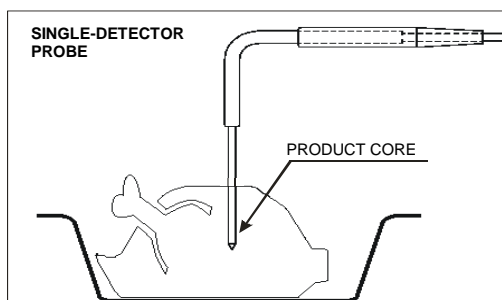

TEMPERATURES

Do not leave the cooked products that are to be chilled/frozen at room temperature.

Avoid humidity losses, which will be detrimental to the conserved fragrance of the product.

We recommend beginning the chilling/freezing programme as soon as the preparation or cooking phase has ended, being careful to insert the product into the equipment at a temperature no lower than +70°C. The cooked product can enter the equipment even at very high temperatures, greater than +100°C, as long as the chamber has been pre-chilled.

In any case it should be taken into consideration that the programme reference times always start from a temperature of +90°C, in positive chilling from +90°C to +3°C and in negative chilling from +90°C to -18°C.

LENGTH

Cooled or frozen processed foodstuffs may be stored in a refrigerator for 5 days of processing with no quality alterations.

For best results we recommend keeping temperature constant throughout the storing (0°C to 4°C), according to the various commodities.

Storing time may be increased to approx. two weeks by using vacuum processing.

After a negative quick cooling cycle, foodstuffs may be stored safely for 3 to 18 months, according to the type of foodstuff processed.

We strongly recommend keeping storing temperature at -20°C or below.

The cooled product should be wrapped in a specific film for foodstuffs (better still, vacuum stored) and provided with a sticker reporting the content [A], date of processing [B] and expiry date [C] written in permanent type ink.

A _____
B _____
C _____

CONTROL PANEL

The illustration shows the equipment control panel, while the list indicates the description and functionality of the individual commands.



A–Display: Displays all the information relative to the menus on the board and the application in progress.

B– HOME button: In any context, if enabled, this allows the user to return immediately to the main screen. If the button is enabled this is indicated by the corresponding back lighting.

C– BACK button: During navigation this button allows the user to return to the previous level in the menu structure, while when any cycle is in progress, it allows the user to modify the control parameters of the process in progress, temporarily saving the modified values.

D– Knob: The clockwise and anticlockwise turning of the knob allows the user to navigate through the various menus on the display, while pressing it allows access to the selected item.

The RGB LED bar, built into the door handle or on the dashboard, takes on a different colour depending on the process in progress:

- Stand-by: **low intensity steady light blue light**
- Chilling/freezing cycle (including infinity, Multy) Defrost and Cooling, in progress: **high intensity flashing light blue light**
- Conservation in progress: **high intensity steady light blue light**
- Freezing in progress: **high intensity steady red light**
- Sanitising in progress: **low intensity steady red light**
- Fault: **steady yellow light**

FIRST START-UP

At the first start-up the operator will be asked to choose the language and the sector.

LANGUAGE SETTING

1. Select LANGUAGE by rotating the knob



2. Press the knob to confirm the selected language

The language can also be changed later (see page 52)



SECTOR SETTING

1. Select the SECTOR by rotating the knob



2. Press the knob to confirm the selected sector

The sector can also be changed later (see page 54)



PROGRAMME

PROGRAMME DESCRIPTIONS

PROGRAMME	DESCRIPTION
STANDARD PROGRAMMES	
SOFT +3°C	Cycle carried out through probe at the core or time, suitable for chilling foods up to +3°C, using a chamber temperature of about 1°C. Cycle suitable for delicate products such as mousse, creams, desserts, vegetables or foods that are not very thick
HARD +3°C	Cycle carried out through probe at the core or time, suitable for chilling foods up to +3°C, using a chamber temperature varying from -15°C to 1°C. Cycle suitable for very dense products, with high grease content or large sized products
IFR	I.F.R. is the patented positive blast chilling system that automatically optimises the process for any type of food, no matter the size and quantity, chilling its surface thanks to the use of a multipoint, three sensor needle probe
SOFT -18°C	Cycle carried out through probe at the core or time, suitable for freezing foods up to -18°C, using a chamber temperature varying from 1°C to -40°C. Cycle suitable for leavened products, baked or cooked foods that are not very thick
HARD -18°C	Cycle carried out through probe at the core or time, suitable for freezing foods up to -18°C, using a chamber temperature that can reach -40°C. Cycle suitable for raw or cooked, large size foods
INFINITY	Time chilling/freezing cycle with infinite duration, suitable for cooling various type food pans. The temperature at the core can be checked
AUTOMATIC PROGRAMMES +3°C - CATERING	
LASAGNE	Cycle dedicated to chilling of lasagne
SOUPS AND SAUCES	Cycle dedicated to chilling of soups and sauces
RICE AND PASTA	Cycle dedicated to chilling of rice and pasta
MEAT	Cycle dedicated to chilling of meat
FISH	Cycle dedicated to chilling of fish
COOKED VEGETABLES	Cycle dedicated to chilling of cooked vegetables
HOT PASTRY	Cycle dedicated to chilling of hot pastry products
DRY PASTRY	Cycle dedicated to chilling of dry pastry products
WALNUTS VEAL	Cycle dedicated to chilling of walnuts veal
AUTOMATIC PROGRAMMES -18°C - CATERING	
LASAGNE	Cycle dedicated to freezing of lasagne
SOUPS AND SAUCES	Cycle dedicated to freezing of soups and sauces
RICE AND PASTA	Cycle dedicated to freezing of rice and pasta
MEAT	Cycle dedicated to freezing of meat
FISH	Cycle dedicated to freezing of fish
COOKED VEGETABLES	Cycle dedicated to freezing of cooked vegetables
RAW VEGETABLES	Cycle dedicated to freezing of raw vegetables
PASTRY	Cycle dedicated to freezing of pastry products
RAW FISH	Cycle dedicated to freezing of raw fish
SUSHI	Cycle dedicated to freezing of Sushi
ANISAKIS 24h*	It is a special blast freezing cycle that enables preventive and total food preservation and restoration. Once the probe reads -20°C at the food core, the appliance will automatically start the " <i>devitalization phase for 24 hours</i> "
ANISAKIS 15h*	It is a special blast freezing cycle that enables preventive and total food preservation and restoration. Once the probe reads -35°C at the food core, the appliance will automatically start the " <i>devitalization phase for 15 hours</i> "
OPISTORKIS 24h	It is a special blast freezing cycle that enables preventive and total food preservation and restoration. Once the probe reads -20°C at the food core, the appliance will automatically start the " <i>devitalization phase for 24 hours</i> "

* **Tested and validated in cooperation with:** University of Naples Federico II - Department of Zootechnical Sciences and Food inspection and the University Research laboratory at the wholesale fish market of Pozzuoli, Naples

AUTOMATIC PROGRAMMES +3°C - PASTRY SHOP	
DOUGH SHEETING	Cycle dedicated to chilling of sheet dough
MIXING IN DIE	Cycle dedicated to chilling of moulded dough
CREAM	Cycle dedicated to chilling of creams
LEAVENED	Cycle dedicated to chilling of leavened products
LEAVENED +10°C	Cycle dedicated to chilling of leavened products +10°C
SHORT PASTRY	Cycle dedicated to chilling of shortcrust dough
STUFFED PRODUCTS	Cycle dedicated to chilling of filled products
TARTS	Cycle dedicated to chilling of tarts
BRIOCHE	Cycle dedicated to chilling of brioche
PANNA COTTA	Cycle dedicated to chilling of panna cotta
YOGURT BOX	Cycle dedicated to preparing of yogurt
AUTOMATIC PROGRAMMES -18°C - PASTRY SHOP	
DOUGH SHEETING	Cycle dedicated to freezing of sheet dough
MIXING IN DIE	Cycle dedicated to freezing of moulded dough
TARTS	Cycle dedicated to freezing of tarts
MOUSSE	Cycle dedicated to freezing of mousse
CROISSANT	Cycle dedicated to freezing of croissants
ICE CREAM	Cycle dedicated to freezing of ice cream
AUTOMATIC PROGRAMMES +3°C - BAKERY	
TARTS	Cycle dedicated to chilling of tarts
BAKED BREAD	Cycle dedicated to chilling of baked bread
CREAM	Cycle dedicated to chilling of creams
LEAVENED	Cycle dedicated to chilling of leavened products
AUTOMATIC PROGRAMMES -18°C - BAKERY	
COOKED TARTS	Cycle dedicated to freezing of baked tarts
RAW TARTS	Cycle dedicated to freezing of unbaked tarts
BAKED BREAD	Cycle dedicated to freezing of baked bread
UNCOOKED BREAD	Cycle dedicated to freezing of unbaked bread
AUTOMATIC PROGRAMMES +3 - ICE CREAM PARLOUR	
PANNA COTTA	Cycle dedicated to chilling of panna cotta
YOGURT BOX	Cycle dedicated to preparing of yogurt
AUTOMATIC PROGRAMMES -18°C - ICE CREAM PARLOUR	
ICE CREAM -14°C	Cycle dedicated to freezing of ice cream -14°C
ICE CREAM	Cycle dedicated to freezing of ice cream
COMPLETE MOUSSE	Cycle dedicated to freezing of complete mousse
MOUSSE	Cycle dedicated to freezing of mousse
FROZEN DESSERT	Cycle dedicated to freezing of frozen dessert
MULTY PROGRAMME	
MULTY	Time chilling/freezing cycle, organised by load levels, with possibility of needle probe reading, providing the time for each level
BANQUETING PROGRAMME	
BANQUETING	Cycle dedicated to the catering sector, excellent for preparation of banqueting products
VACUUM PROGRAMME	
VACUUM	Cycle dedicated to the catering sector for preparation of products before a vacuum-packing phase
THAWING PROGRAMME	
THAWING	Cycle carried out by means of temperature probe or by time, dedicated to controlled food defrosting
PROVING PROGRAMME	
PROVING	Time cycle, dedicated to direct leavening of foods
RETARDER PROVING	Time cycle, dedicated to scheduled leavening of foods
SMART ON PROGRAMME	
SMART ON	Cycle with automatic start. Once a hot product is inserted if an increase in the chamber temperature is detected, after 5 minutes a Soft +3°C cycle will start, either by probe or time, based on whether or not the needle is used.

STANDARD PROGRAMMES

Chilling/freezing cycles pre-set by the manufacturer which can be activated by selecting them directly from the initial screen, SOFT +3°C, HARD +3°C, SOFT -18°C and HARD -18°C.

During execution of the cycle the parameters can be viewed and modified temporarily. The new values will be valid exclusively for the cycle in progress.

1. Select the desired cycle by rotating the knob

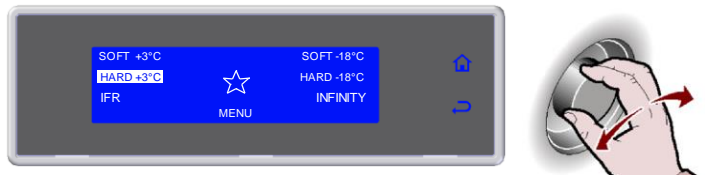

2. Press the knob to activate the selected cycle

During the cycle it is possible:

- to view and modify the default parameters by selecting SET (see page 42)
- to stop the cycle by selecting STOP



Note: the modified parameters will be saved only for the cycle in progress



3. Cycle ended, automatic conservation phase

During conservation it is possible:

- to view and modify the default parameters by selecting SET (see page 42)
- to activate a manual defrost by selecting 
- to stop the cycle by selecting STOP



Note: the modified parameters will be saved only for the cycle in progress.

If not required, manual defrosting is not performed

PROGRAMME I.F.R.

The IFR is an innovative patented system of positive quick cooling which allows the cycle optimisation for each type of foodstuffs ***by preventing superficial freezing***. Temperatures are detected by a three-sensor multipoint needle probe. The position inside the foodstuff is determined univocally by a reference disk located along the needle. (ref. par. "Core probe").



1. Select the desired cycle by rotating the knob



2. Press the knob to activate the selected cycle

During the cycle it is possible:

- select SET to change the fan speed
- to stop the cycle by selecting STOP

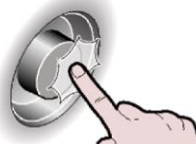

Note: the modified value will only be saved for the cycle in progress

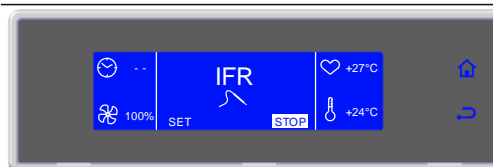

3. Cycle ended, automatic conservation phase

During conservation it is possible:

- to view and modify the default parameters by selecting SET (see page 42)
- to activate a manual defrost by selecting
- to stop the cycle by selecting STOP



*Note: the modified parameters will be saved only for the cycle in progress.
If not required, manual defrosting is not performed*

PROGRAMME INFINITY

Time chilling/freezing cycle with infinite duration, suitable for cooling various type food pans. The temperature at the core can be checked.

1. Select the desired cycle by rotating the knob

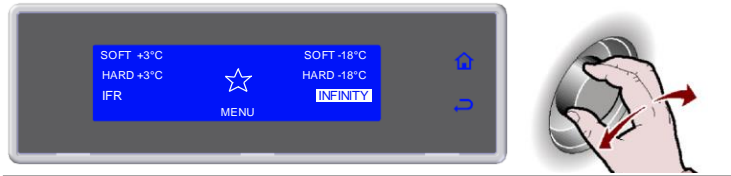

4. Cycle ended, automatic conservation phase

During conservation it is possible:

- select SET to view and modify the chamber temperature and fan speed
- to stop the cycle by selecting STOP

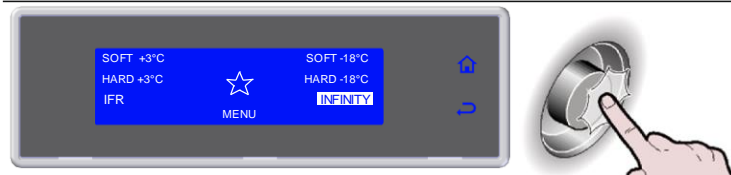

Note: the modified values will be saved

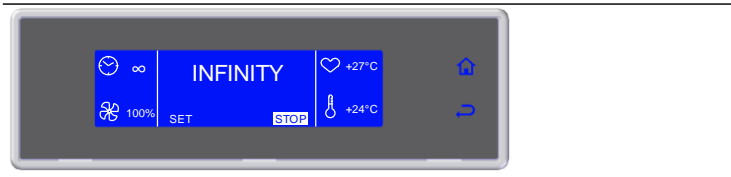

FAVOURITE PROGRAMMES

A library consisting in 10 cycles selected from those stored and labelled as favourites ☆ (see page 29)

1. Select ☆ by rotating the knob

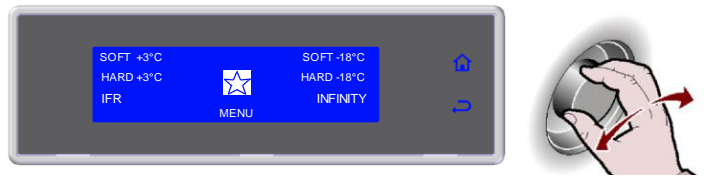

2. Press the knob to enter section FAVOURITE PROGRAMMES



3. Select the desired cycle by rotating the knob

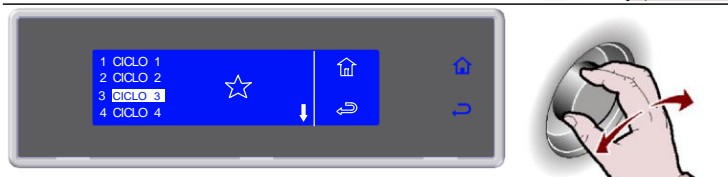

4. Press the knob to activate the selected cycle
During the cycle it is possible:
- to view and modify the default parameters by selecting SET (see page 36)
 - to stop the cycle by selecting STOP

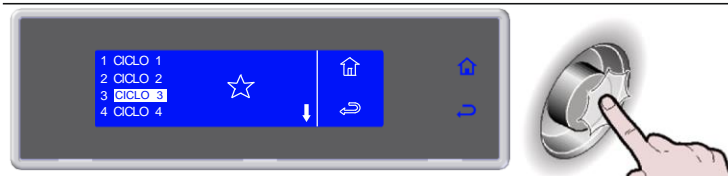

Note: the modified parameters will be saved only for the cycle in progress



5. Cycle ended, automatic conservation phase

During conservation it is possible:

- to view and modify the default parameters by selecting SET (see page 42)
- to activate a manual defrost by selecting ❄️
- to stop the cycle by selecting STOP



*Note: the modified parameters will be saved only for the cycle in progress.
If not required, manual defrosting is not performed*

AUTOMATIC PROGRAMMES

These programmes are manufacturer recommended work cycles. During the cycle the parameters can be viewed, but not modified.

1. Select MENU by rotating the knob



2. Press the knob to enter section MENU



3. Select AUTOMATIC by rotating the knob



4. Press the knob to enter section AUTOMATIC



5. Select the type of desired cycle by rotating the knob

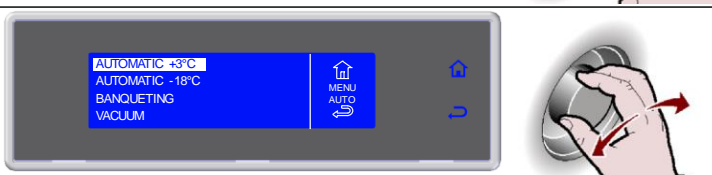

6. Press the knob to enter into the selected type of cycle



7. Select the desired cycle by rotating the knob

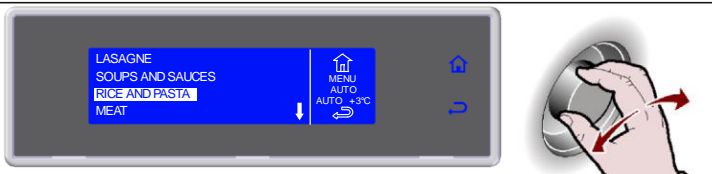

8. Press the knob to activate the selected cycle



9. Select the quantity of load to be treated, minimum, medium, maximum



10. Press the knob to activate the selected cycle

During the cycle it is possible:

- to view the default parameters by selecting INFO
- to stop the cycle by selecting STOP

Note: the parameters cannot be modified

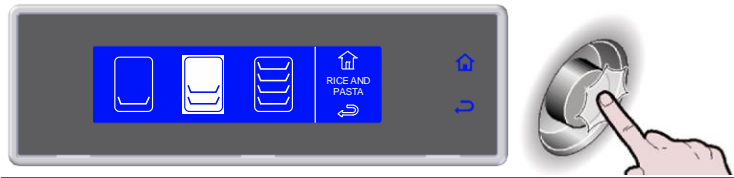

12. Cycle ended, automatic conservation phase

During conservation it is possible:

- to view the default parameters by selecting INFO
- to activate a manual defrost by selecting 
- to stop the cycle by selecting STOP

*Note: the parameters cannot be modified.
If not required, manual defrosting is not performed*



STORED PROGRAMMES

These are 10 chilling cycles and 10 freezing cycles that can be configured based on the needs of the user, the names of which can be freely set.

These cycles already have default settings set up by the manufacturer: once modified by the user the new values can be saved in the memory and recalled at a subsequent start of that cycle.

10 of these programmes can be made FAVOURITES, organising them based on the needs of the user.

1. Select MENU by rotating the knob



2. Press the knob to enter section MENU



3. Press the knob to enter section STORED



4. Press the knob to enter section STORED



5. Select the type of desired cycle by rotating the knob



6. Press the knob to enter into the selected type of cycle



7. Select the desired cycle by rotating the knob

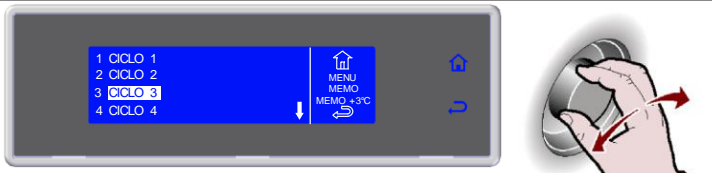

8. Press the knob to activate the selected cycle

During the cycle it is possible:

- View, modify the default parameters and make it a favourite by selecting SET
- to stop the cycle by selecting STOP



Note: the modified parameters can be saved once the new value is inserted by selecting



, otherwise, by selecting , the modifications will be active only for the cycle in progress.

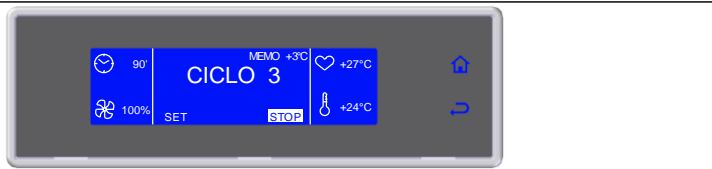

If the modifications are saved the user will be asked to assign a name to the cycle. use the

knob to enter the name and press  to save it.

To make a cycle a favourite, select MAKE FAVOURITE, found at the end of the parameters list, and enter the desired position. The cycle will automatically overwrite the one in

that position. Save by selecting .

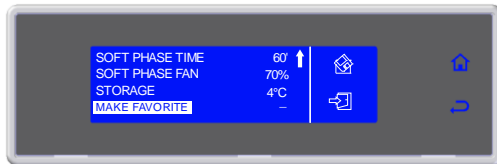



9. Cycle ended, automatic conservation phase

During conservation it is possible:

- View, modify the default parameters and make it a favourite by selecting SET
- to activate a manual defrost by selecting 
- to stop the cycle by selecting STOP

Note: the modified parameters can be saved once the new value is inserted by selecting

, otherwise, by selecting , the modifications will be active only for the cycle in progress.

If the modifications are saved the user will be asked to assign a name to the cycle. use the

knob to enter the name and press  to save it.

If not required, manual defrosting is not performed



MULTY

Chilling/freezing cycle **by time** organised by load levels.
The number of levels available varies depending on the equipment.

1. Select MENU by rotating the knob



2. Press the knob to enter section MENU



3. Select MULTY by rotating the knob



4. Press the knob to enter section MULTY



5. Enter the time for each level and confirm it with the knob

During the cycle it is possible:

- to view and modify the default parameters by selecting SET (see page 42)
- to stop the cycle by selecting 

Note: the modified parameters will be saved

At the expiry of the set value for each individual level, the buzzer and the flashing value alert the user that the product can be withdrawn.

Once all the set times have expired, automatic conservation phase

During conservation it is possible:

- to view and modify the default parameters by selecting SET (see page 42)

Note: the modified parameters will be saved

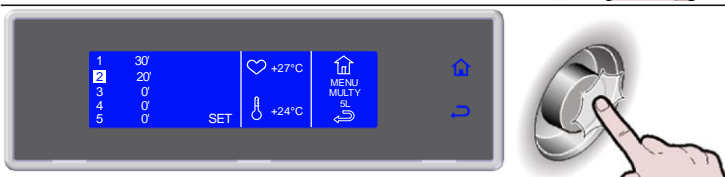
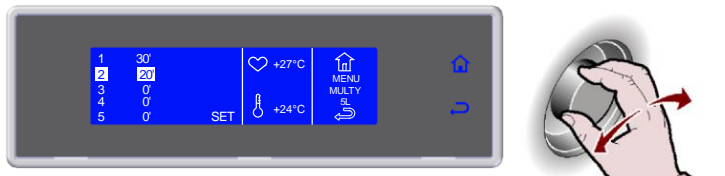

COOLING

It is advisable to run a cooling cycle prior to selecting any slaughter cycle.

1. Select MENU by rotating the knob



2. Press the knob to enter section MENU



3. Select COOLING by rotating the knob



4. Press the knob to activate the selected cycle

During the cycle it is possible:

- to view and modify the default parameters by selecting SET (see page 42)
- to stop the cycle by selecting STOP



Note: the modified parameters will be saved only for the cycle in progress



5. Cycle ended, automatic conservation phase

During conservation it is possible:

- to view and modify the default parameters by selecting SET (see page 42)
- to stop the cycle by selecting STOP



Note: the modified parameters will be saved only for the cycle in progress

FUNCTIONS

DEFROST

If not required, the function will not be activated and the display will alternate between showing the defrosting symbol  and the message "NOT REQUIRED", accompanied by the sound of the buzzer.

1. Select MENU by rotating the knob



2. Press the knob to enter section MENU

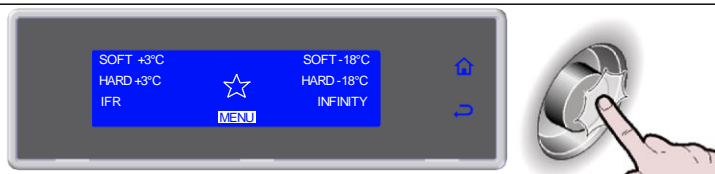

3. Select FUNCTIONS by rotating the knob



4. Press the knob to enter section FUNCTIONS



5. Select DEFROST by rotating the knob



6. Press the knob to activate the selected cycle

- During the cycle it is possible
- to view and modify the default parameters by selecting SET (see page 42)
 - to stop the cycle by selecting STOP



Note: the modified parameters will be saved only for the cycle in progress



7. Cycle ended



SANITATION



NOTA: the germicidal lamp kit is not supplied as standard equipment. It is an optional item. Should you purchase the kit, please follow the maintenance instructions to maintenance.

1. Select MENU by rotating the knob



2. Press the knob to enter section MENU



3. Select FUNCTIONS by rotating the knob



4. Press the knob to enter section FUNCTIONS



5. Select SANITATION by rotating the knob



6. Press the knob to activate the selected cycle

During the cycle it is possible:

- to view and modify the time of sanitation by selecting SET (see page 42)
- to stop the cycle by selecting STOP



Note: the modified parameters will be saved only for the cycle in progress



7. Cycle ended



STORAGE

Storing cycles and quick cooling cycles can be started separately.

1. Select MENU by rotating the knob



2. Press the knob to enter section MENU



3. Select FUNCTIONS by rotating the knob



4. Press the knob to enter section FUNCTIONS



5. Select STORAGE by rotating the knob



6. Press the knob to enter into the STORAGE



7. Select the type of conservation by rotating the knob

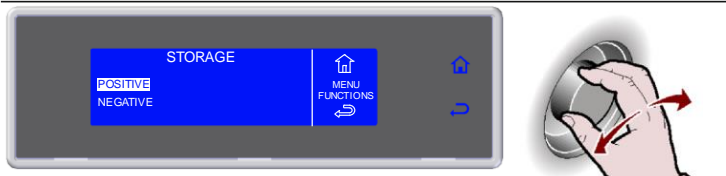

8. Press the knob to activate the selected cycle

During the cycle it is possible:

- to view and modify the default parameters by selecting SET (see page 42)
- to activate a manual defrost by selecting ❄️
- to stop the cycle by selecting STOP



Note: the modified parameters will be saved only for the cycle in progress. If not required, manual defrosting is not performed

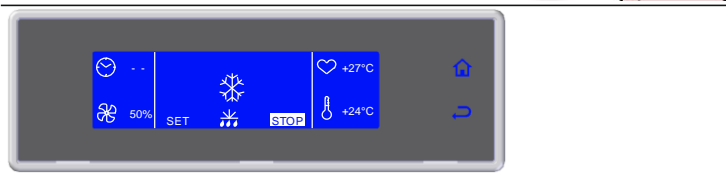

THAWING

The defrost cycles with probe or by time are automatic. During the cycle the parameters can be modified and the temperature can be selected or the time at which the food should be defrosted and ready for use. In the event of time defrosting the operator can decide to change only the cycle end date acting on the date on the screen of the cycle in progress. This action is valid only if you are in the first phase (preservation)

1. Select MENU by rotating the knob



2. Press the knob to enter section MENU

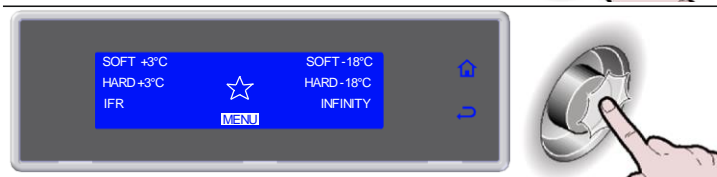

3. Select FUNCTIONS by rotating the knob



4. Press the knob to enter section FUNCTIONS



5. Select THAWING by rotating the knob



6. Press the knob to enter into the THAWING



7. Rotate the knob to select the type most suited for the product to be treated



8. Press the knob to activate the selected cycle

In case of time defrosting the cycle will begin immediately with the date and time values set by the manufacturer.



- Once the cycle has been started (time defrosting) the cycle end date and time can be changed, but only during the first phase (preservation).



- Rotate the knob to select the date and time

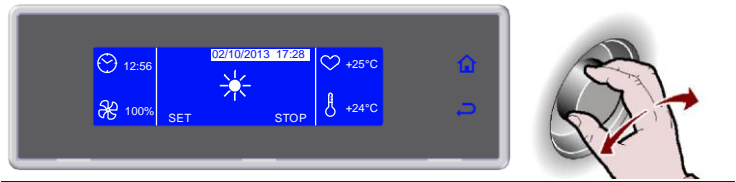

- Press the knob to enter the date and time value change mode

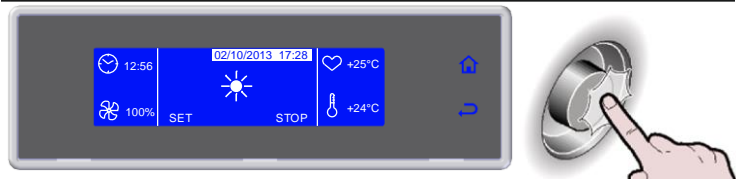

- Select the new value by rotating the knob



- Press the knob to confirm the new value and move to the next one



- Select  to confirm and exit from the function



During the cycle it is possible:

- to view and modify the default parameters by selecting SET (see page 42)
- to stop the cycle by selecting STOP

Note: the modified parameters will be saved only for the cycle in progress. In time defrost if the times are changed the cycle end will automatically be recalculated.

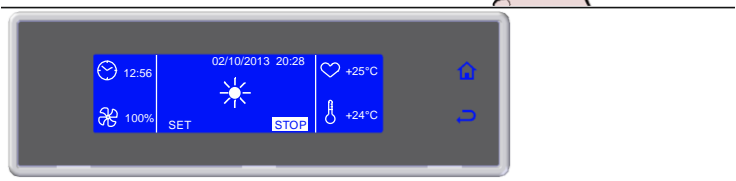

9. Cycle ended, automatic conservation phase

During conservation it is possible:

- to view and modify the default parameters by selecting SET (see page 42)
- to activate a manual defrost by selecting 
- to stop the cycle by selecting STOP

Note: the modified parameters will be saved only for the cycle in progress. If not required, manual defrosting is not performed.



PROVING

The *leavening* and *retarding* cycles are automatic. During the cycle the parameters can be modified to select the temperature or the time at which the food should be leavened and ready for use.

The operator can decide to change only the end cycle date by acting on the date shown on the screen of the cycle in progress, but only during the first phase (preservation), easily scheduling the moment at which the product should be perfectly leavened.

1. Select MENU by rotating the knob

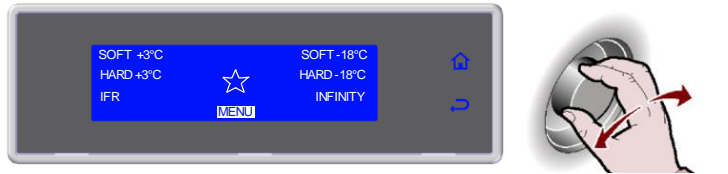

2. Press the knob to enter section MENU



3. Select FUNCTIONS by rotating the knob



4. Press the knob to enter section FUNCTIONS



5. Select PROVING by rotating the knob



6. Press the knob to enter into the PROVING

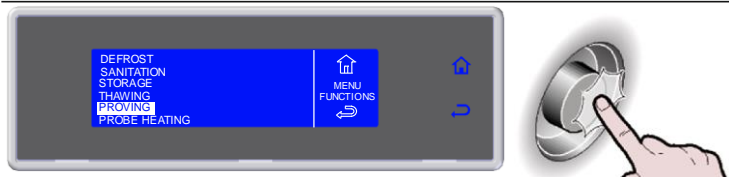

7. Select by rotating the knob:
 - *PROVING* for a direct leavening cycle
 - *RETARDER PROVING* for a scheduled leavening cycle



8. Press the knob to activate the selected cycle
The cycle will begin immediately with the date and time values set by the manufacturer.



- Once the cycle has been started the cycle end date and time can be changed, but only during the first phase (preservation).



- Rotate the knob to select the date and time

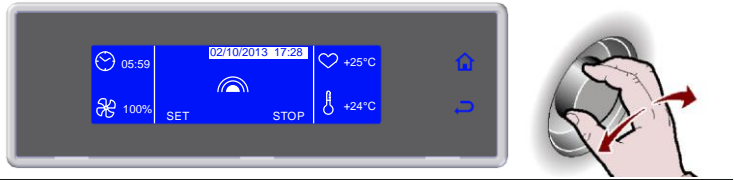

- Press the knob to enter the date and time value change mode

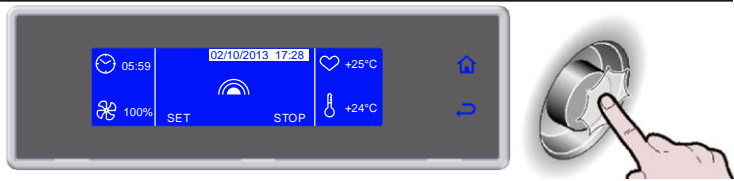

- Select the new value by rotating the knob



- Press the knob to confirm the new value and move to the next one



- Select  to confirm and exit from the function



During the cycle it is possible:

- to view and modify the default parameters by selecting SET (see page 42)
- to stop the cycle by selecting STOP

Note: the modified parameters will be saved only for the cycle in progress. If the times are changed the cycle end will automatically be recalculated.

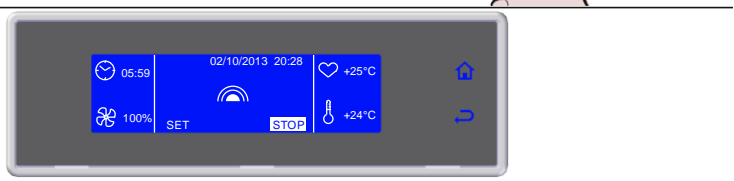

9. Cycle ended, automatic conservation phase

During conservation it is possible:

- to view and modify the default parameters by selecting SET (see page 42)
- to activate a manual defrost by selecting



- to stop the cycle by selecting STOP

Note: the modified parameters will be saved only for the cycle in progress. If not required, manual defrosting is not performed.



PROBE HEATING

Heating of the needle probe is activated automatically, only on a cycle with needle and negative temperature probe core, after the cycle in progress stops, selecting STOP, and after the subsequent opening of the door by the operator.

1. Please wait



2. Remove the probe

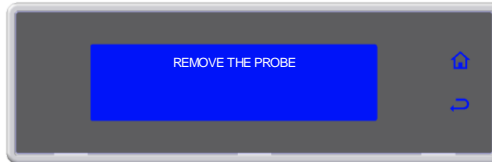

It is always possible to start the function manually.

1. Select MENU by rotating the knob



2. Press the knob to enter section MENU

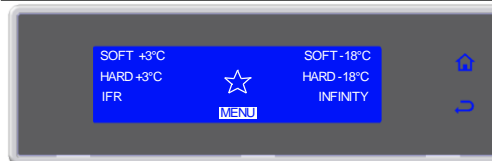

3. Select FUNCTIONS by rotating the knob

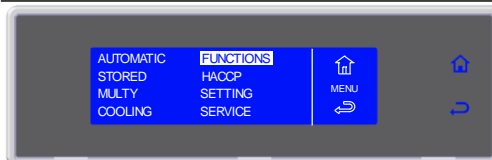

4. Press the knob to enter section FUNCTIONS



5. Select PROBE HEATING by rotating the knob

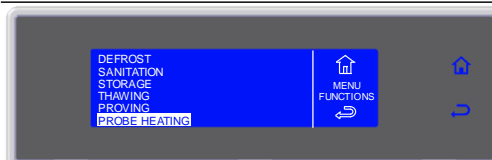

6. Press the knob to activate the selected function

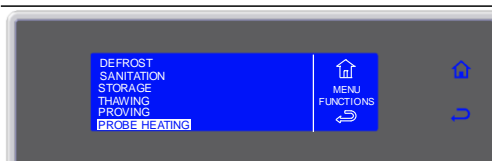

7. Please wait



8. Remove the probe



In the event that the temperature read by the needle core sensor is not negative, the function will not be activated.

1. Not needed

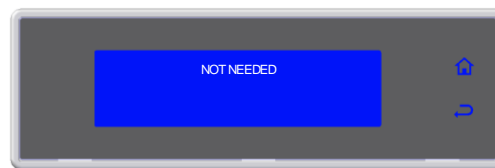

** VIEW / EDIT PARAMETERS CYCLE

1. During the cycle, select SET by rotating the knob

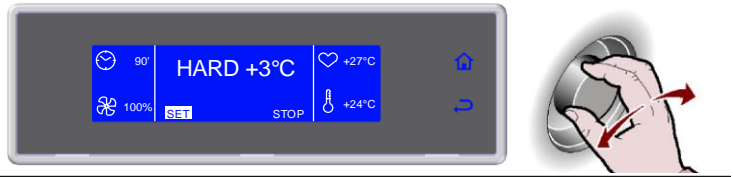

2. Press the knob to enter the parameters list



3. Select the parameter to be modified by rotating the knob

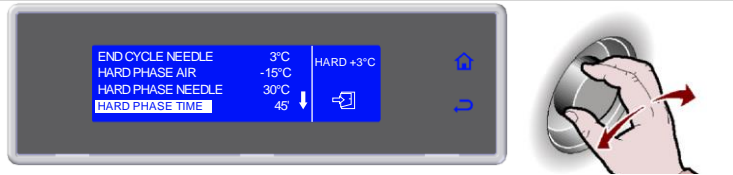

4. Press the knob to modify the value



5. Select the new value, by rotating the knob

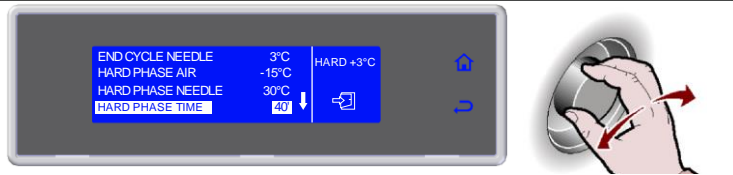

6. Press the knob to confirm the new value

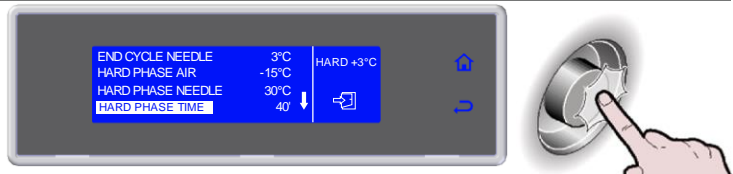

7. Press to exit the parameters list

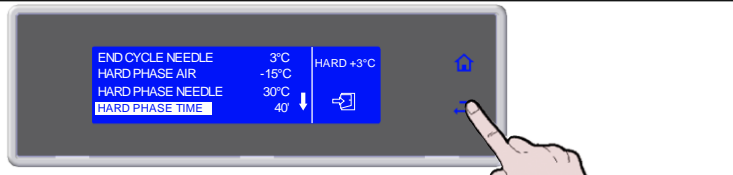

HACCP

1. Select MENU by rotating the knob

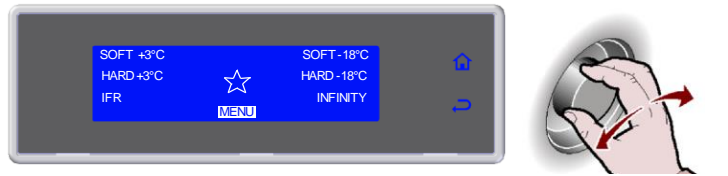

2. Press the knob to enter section MENU



3. Select HACCP by rotating the knob



4. Press the knob to enter section HACCP

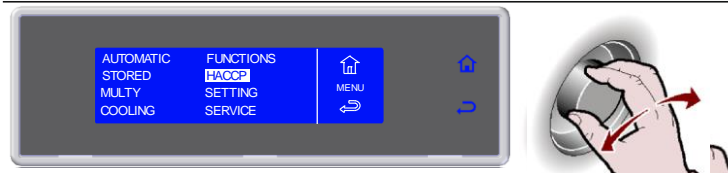

5. Select the chosen function by rotating the knob



VIEW BY DATE

6. Press the knob to enter the selected function



7. Select the chosen function by rotating the knob

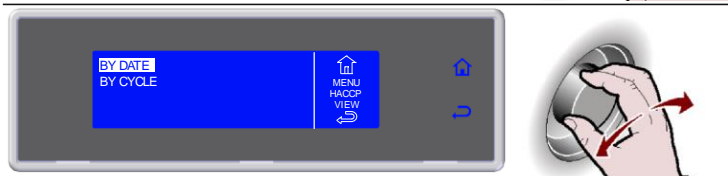

8. Press the knob to enter the selected function

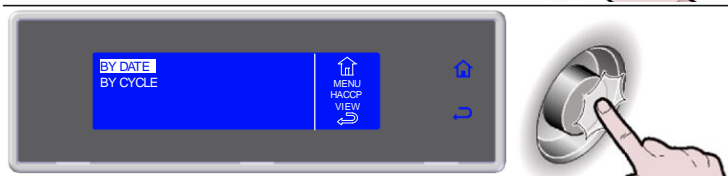

9. Enter the data by turning the knob and press to confirm the value and move to the next one until ENTER is selected

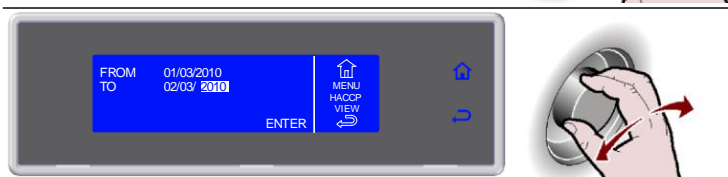

10. Press the knob to view the desired cycles



11. Select the cycle to be viewed



12. Press the knob to view the selected cycle



13. The parameters list is displayed



VIEW BY CYCLE

6. Press the knob to enter the selected function



7. Select the chosen function by rotating the knob



8. Press the knob to enter the selected function



9. Select the cycle to be viewed



10. Press the knob to view the selected cycle

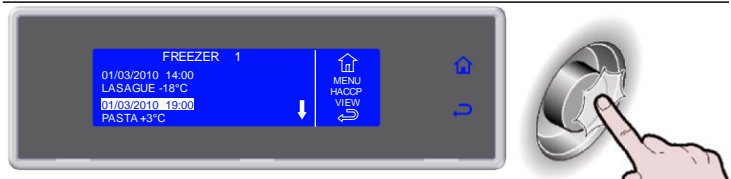

11. The parameters list is displayed

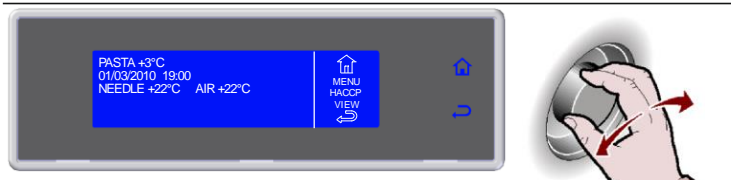

PRINT BY DATE

NOTE: the printer is not supplied as standard equipment. It is an optional item.
Connect the printer from the rear of the unit, using the MATE-N-LOK connectors on the electrical panel, identified with the letters **R** (power) and **S** (signal).

6. Press the knob to enter the selected function



7. Select the chosen function by rotating the knob



8. Press the knob to enter the selected function

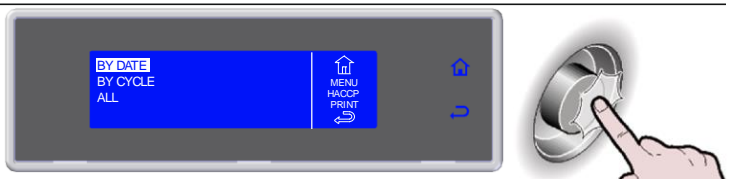

9. Enter the data by turning the knob and press to confirm the value and move to the next one until ENTER is selected



10. Press the knob to start printing

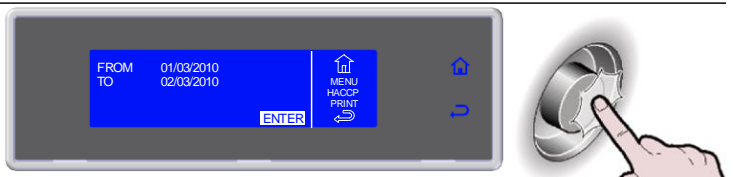

11. Printing in progress

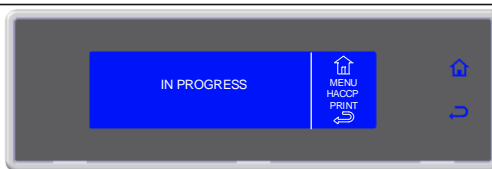

PRINT BY CYCLE

NOTE: the printer is not supplied as standard equipment. It is an optional item.
Connect the printer from the rear of the unit, using the MATE-N-LOK connectors on the electrical panel, identified with the letters **R** (power) and **S** (signal).

6. Press the knob to enter the selected function



7. Select the chosen function by rotating the knob

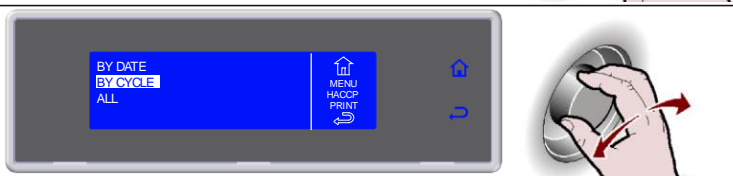

8. Press the knob to enter the selected function



9. Select the cycle to be viewed



10. Press the knob to confirm the selected cycle



11. Press the knob to start printing



12. Printing in progress

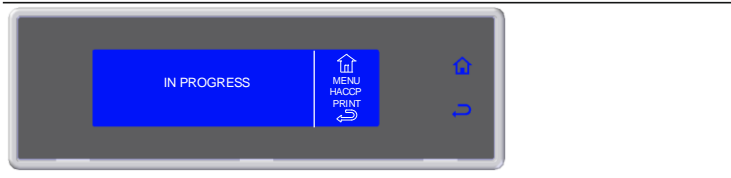

PRINT ALL

NOTE: the printer is not supplied as standard equipment. It is an optional item. Connect the printer from the rear of the unit, using the MATE-N-LOK connectors on the electrical panel, identified with the letters **R** (power) and **S** (signal).

6. Press the knob to enter the selected function



7. Select the chosen function by rotating the knob



8. Press the knob to enter the selected function

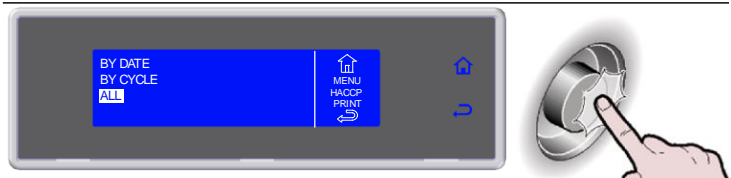

9. Press the knob to start printing

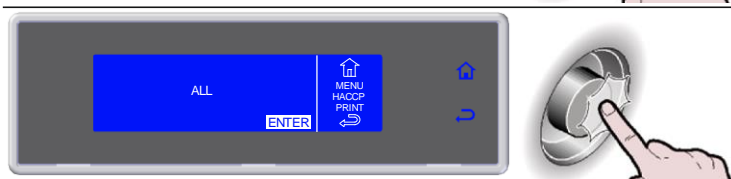

10. Printing in progress



DOWNLOAD DATA BY DATE

Insert a USB flash drive (*not supplied*) into the USB port “Type A” on the protection of unit’s electrical panel, for models 10-20kg (in order to access the USB port, please refer to the section entitled "ELECTRICAL PANEL MAINTENANCE"). Mod.72-144 kg on the USB port is located on the dashboard.

6. Press the knob to enter the selected function
USB memory presence is checked

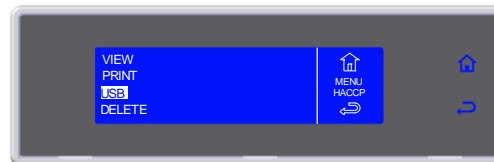

7. Select the chosen function by rotating the knob

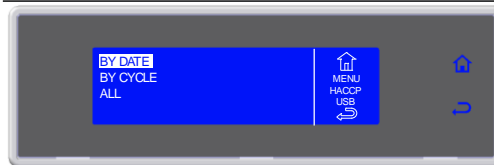

8. Press the knob to enter the selected function

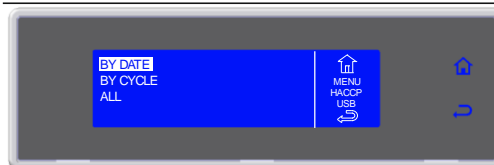

9. Enter the date by rotating the knob and select ENTER

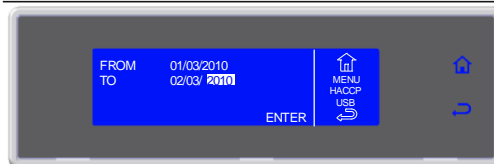

10. Press the knob to start downloading data

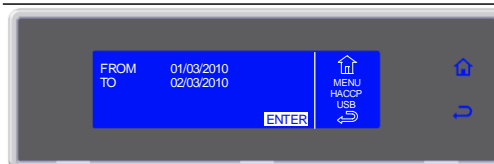

11. Data download in progress

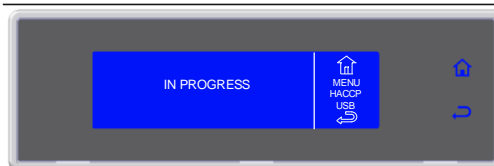

DOWNLOAD DATA BY CYCLE

Insert a USB flash drive (*not supplied*) into the USB port “Type A” on the protection of unit’s electrical panel, for models 10-20kg (in order to access the USB port, please refer to the section entitled "ELECTRICAL PANEL MAINTENANCE"). Mod.72-144 kg on the USB port is located on the dashboard.

6. Press the knob to enter the selected function
USB memory presence is checked



7. Select the chosen function by rotating the knob



8. Press the knob to enter the selected function



9. Select the cycle to be viewed



10. Press the knob to confirm the selected cycle



11. Press the knob to start downloading data



12. Data download in progress



DOWNLOAD ALL

Insert a USB flash drive (*not supplied*) into the USB port "Type A" on the protection of unit's electrical panel, for models 10-20kg (in order to access the USB port, please refer to the section entitled "ELECTRICAL PANEL MAINTENANCE"). Mod.72-144 kg on the USB port is located on the dashboard.

6. Press the knob to enter the selected function
USB memory presence is checked



7. Select the chosen function by rotating the knob



8. Press the knob to enter the selected function

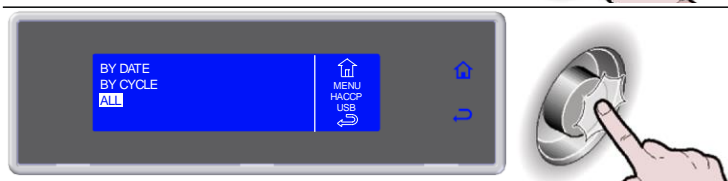

9. Press the knob to start downloading data



10. Data download in progress

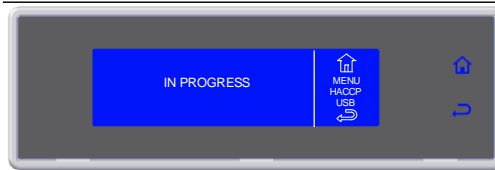

DELETE DATA BY DATE

6. Press the knob to enter the selected function



7. Select the chosen function by rotating the knob



8. Press the knob to enter the selected function

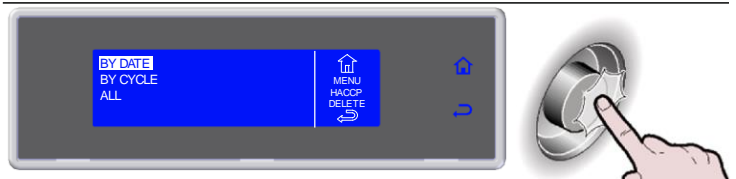

9. Enter the data by turning the knob and press to confirm the value and move to the next one until ENTER is selected

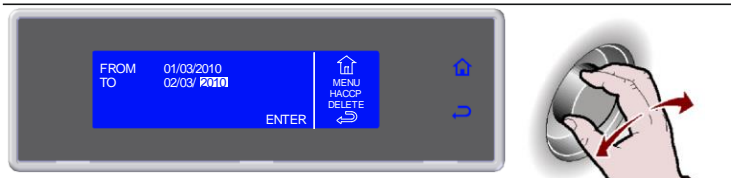

10. Press the knob to start the procedure

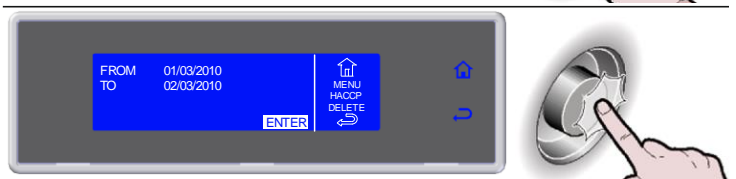

11. Data deletion in progress

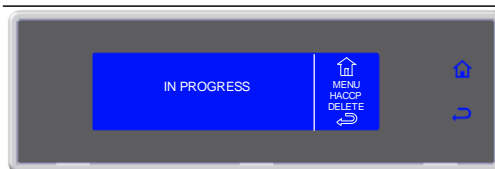

DELETE DATA BY CYCLE

6. Press the knob to enter the selected function



7. Select the chosen function by rotating the knob



8. Press the knob to enter the selected function

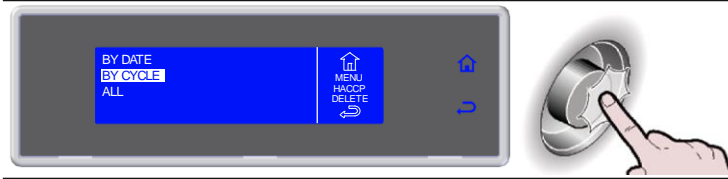

9. Select the cycle to be viewed



10. Press the knob to confirm the selected cycle

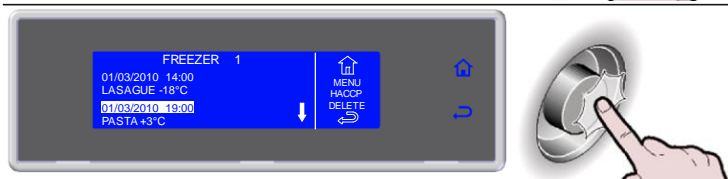

11. Press the knob to start the procedure



12. Data deletion in progress



DELETE ALL

6. Press the knob to enter the selected function



7. Select the chosen function by rotating the knob

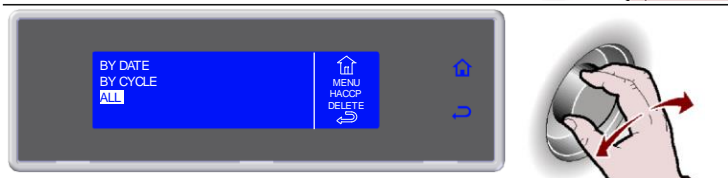

8. Press the knob to enter the selected function



9. Press the knob to start the procedure



10. Data deletion in progress



SETTINGS

LANGUAGE

1. Select MENU by rotating the knob



2. Press the knob to enter section MENU

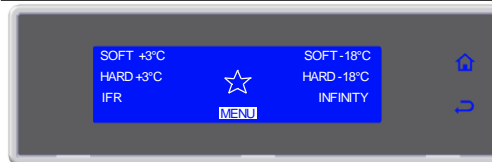

3. Select SETTING by rotating the knob



4. Press the knob to enter section SETTING

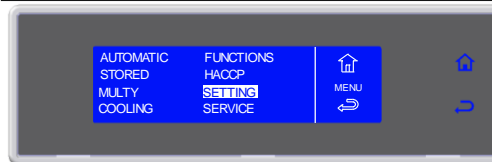

5. Select LANGUAGE by rotating the knob

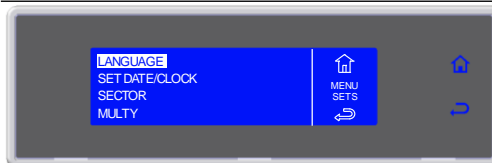

6. Press the knob to enter section LANGUAGE

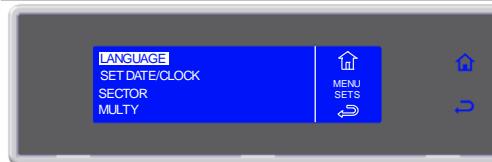

7. Select LANGUAGE by rotating the knob



8. Press the knob to confirm the selected language

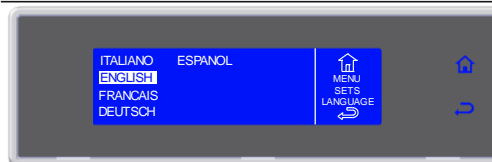

SET DATE/CLOCK

1. Select MENU by rotating the knob



2. Press the knob to enter section MENU

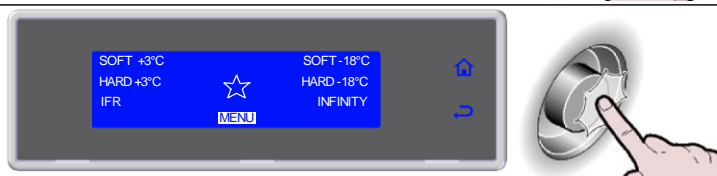

3. Select SETTING by rotating the knob



4. Press the knob to enter section SETTING



5. Select DATA/CLOCK by rotating the knob



6. Press the knob to enter section DATA/CLOCK



7. Select the new value by rotating the knob



8. Press the knob to confirm the new value and move to the next one

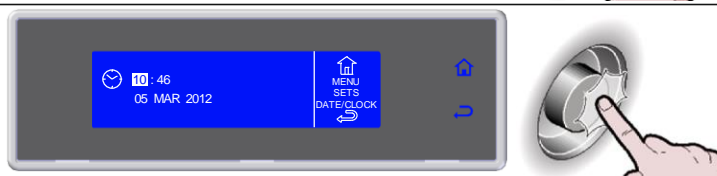

9. Select to confirm and exit from the function

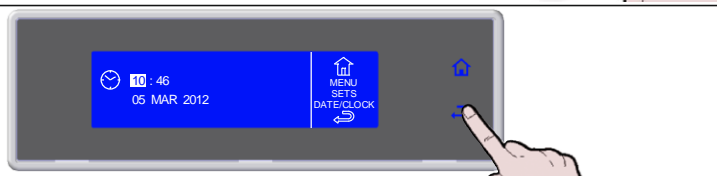

SECTOR

1. Select MENU by rotating the knob



2. Press the knob to enter section MENU



3. Select SETTING by rotating the knob

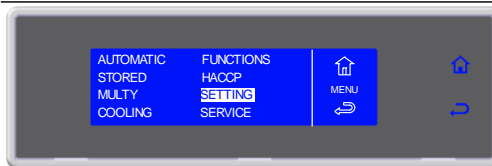

4. Press the knob to enter section SETTING

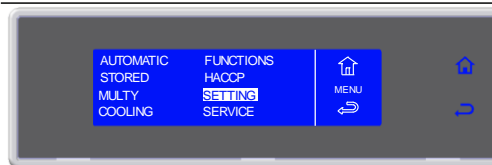

5. Select SECTOR by rotating the knob

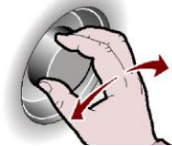
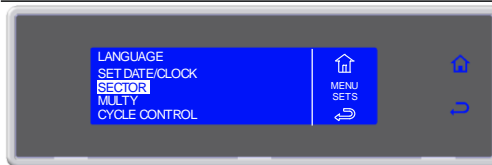

6. Press the knob to enter section SECTOR

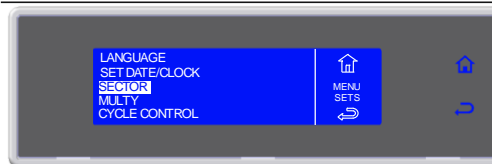

7. Press the knob to confirm the selected sector

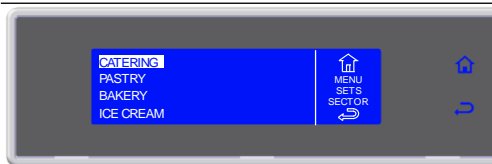

8. Press the knob to confirm

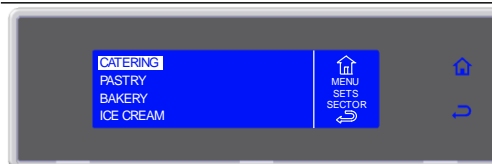

MULTY

The number of levels available varies depending on the equipment.

1. Select MENU by rotating the knob

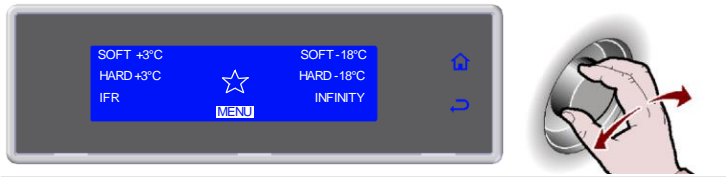

2. Press the knob to enter section MENU

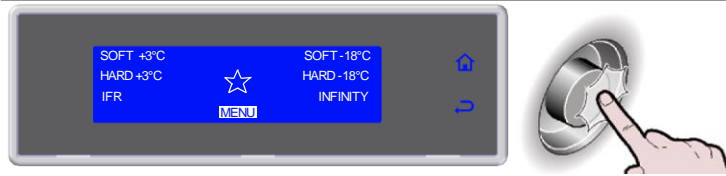

3. Select SETTING by rotating the knob



4. Press the knob to enter section SETTING



5. Select MULTY by rotating the knob



6. Press the knob to enter section MULTY



7. Use the knob to select the number of levels corresponding to the equipment used



8. Press the knob to confirm



CYCLE CONTROL - AUTO OR MANUAL

You can choose to control the cycle in automatic mode (AUTO) or by means of operator choice, timed or using the probe in the core (MANUAL).
The default cycle control setting is automatic mode (AUTO).

1. Select MENU by rotating the knob



2. Press the knob to enter section MENU



3. Select SETTING by rotating the knob



4. Press the knob to enter section SETTING



5. Select CYCLE CONTROL by rotating the knob



6. Press the knob to enter section CYCLE CONTROL



7. Select the desired type of cycle control



8. Press the knob to confirm



SERVICE

ALARMS

The presence of an active alarm is signalled by the buzzer and the display shows the event alternating with the screen showing the process in progress. The RGB bar turns yellow.
The alarms are recorded on a list.

The presence of an alarm stored on the list is indicated by the symbol .
You can record up to a maximum of 42 alarms. Any additional event overwrites the oldest one.

1. Select MENU by rotating the knob



2. Press the knob to enter section MENU



3. Select SERVICE by rotating the knob



4. Press the knob to enter section SERVICE



5. Select ALARMS by rotating the knob



6. Press the knob to view the list ALARMS



7. View the alarms list by rotating the knob

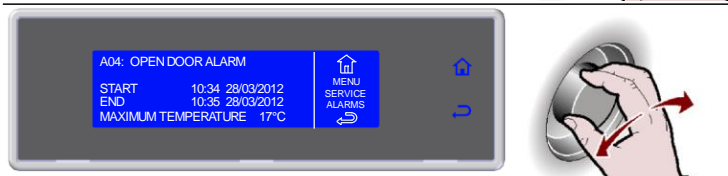

ALARMS TABLE

FAULT	CAUSE	REMEDY
The display board does not switch on	No power supply Blown fuse Loosened connections	Check the connection to the power mains Replace fuses (qualified technician) Check connection fitting
Compressor failure	High and Low-pressure pressureswitch on Clicker on Contactor failure Compressor thermal relay on	Qualified technician required Qualified technician required Qualified technician required Qualified technician required
The compressor is working but the cabinet is not cooling	Frosted evaporator No coolant inside the refrigerating system Delivery solenoid valve failure Condenser dirty	Open the door and carry out the defrost cycle Qualified technician required Qualified technician required Clean the condenser
Evaporator fans are not working	Fan failure or short-circuit Door micro failure	Qualified technician required Qualified technician required
The condenser fans do not work	Faulty pressure switch Faulty fan Faulty pick-up condenser Lack of consent from compressor solenoid switch	Qualified technician required Qualified technician required Qualified technician required Qualified technician required
Lack of evaporator defrosting	Incorrect defrosting programming	Check the defrosting cycle programming
ALARM/ EVENT	CAUSE	REMEDY
High temperature alarm (in conservation)	Room Temp above set value	If the temperature is not within the specified range, apply to a qualified technician
Low temperature alarm (in conservation)	Room Temp below set value	If the temperature is not within the specified range, apply to a qualified technician
Limit temperature alarm (in chilling/freezing)	Cell or core temperature higher than the set value	If the temperature is not within the specified range, apply to a qualified technician
Room probe alarm	Room Probe interrupted	Qualified technician required
Evaporator probe alarm	Evap Probe interrupted	Qualified technician required
Condenser probe alarm	Cond Probe interrupted	Qualified technician required
Dirty condenser alarm	Condenser dirty	Clean the condenser
Point needle probe alarm	Needle Probe interrupted	Qualified technician required
Underskin needle probe alarm	Sub-dermis needle probe interrupted	Qualified technician required
External needle probe alarm	External needle probe interrupted	Qualified technician required
Electr.box probe alarm	Electrical panel probe interrupted	Qualified technician required
Electr.box overtemp. alarm	Electrical panel temperature higher than the set value	Qualified technician required
Open door alarm	QC room door open Door micro faulty	Close the door Qualified technician required
BlackOut alarm	No power supply	When power is restored, check the max. temperature reached inside the room
High pressure alarm	Intervention by high pressure switch	Qualified technician required
Low pressure alarm	Intervention by low pressure switch	Qualified technician required
Compressor overload alarm	Compressor thermal relay on	Qualified technician required
Mother board communication alarm	Communication between the panel board and the display board interrupted	Qualified technician required
Mother board EEPROM alarm	Data memory corrupted	Qualified technician required
Panel board EEPROM alarm	Data memory corrupted	Qualified technician required
Needle probe 1 alarm	Needle Probe 1 interrupted	Qualified technician required
Needle probe 2 alarm	Needle Probe 2 interrupted	Qualified technician required

If the fault is not corrected by following the above instructions ask for skilled assistance and avoid carrying out any other operations, especially on the electricals. When informing the servicing company of the fault, state 1 and 5 numbers (model and serial number).

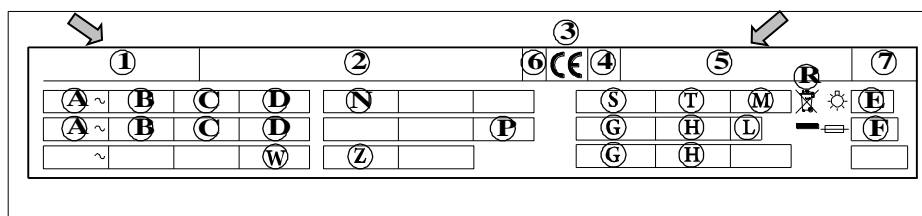

RESET ALLARMI

1. Select MENU by rotating the knob

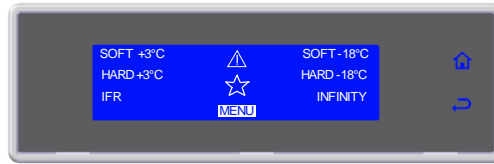

2. Press the knob to enter section MENU



3. Select SERVICE by rotating the knob



4. Press the knob to enter section SERVICE

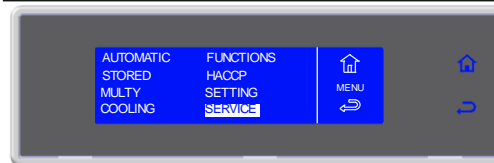

5. Select ALARMS RESET by rotating the knob

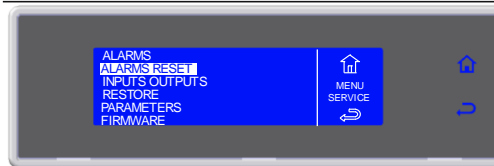

6. Press the knob to enter section ALARMS RESET



7. Wait



INPUTS OUTPUTS

1. Select MENU by rotating the knob



2. Press the knob to enter section MENU

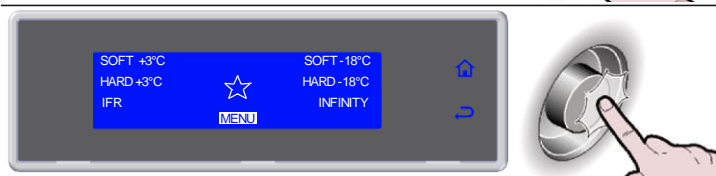

3. Select SERVICE by rotating the knob



4. Press the knob to enter section SERVICE



5. Select INPUTS OUTPUTS by rotating the knob

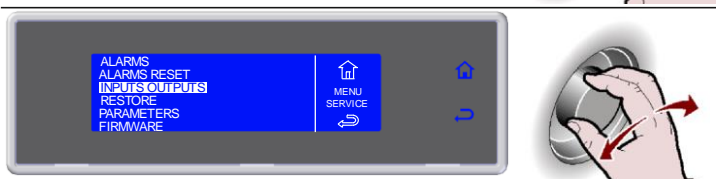

6. Press the knob to view the list INPUTS OUTPUTS



7. Select to exit from the view

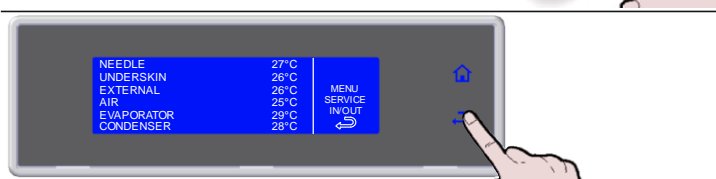

RESTORE

This function restores the original parameters.

ATTENTION: in case of use of this function as a user, contact the manufacturer for the exact settings of the configuration parameters.

1. Select MENU by rotating the knob



2. Press the knob to enter section MENU



3. Select SERVICE by rotating the knob



4. Press the knob to enter section SERVICE



5. Select RESTORE by rotating the knob



6. Press the knob to enter section RESTORE

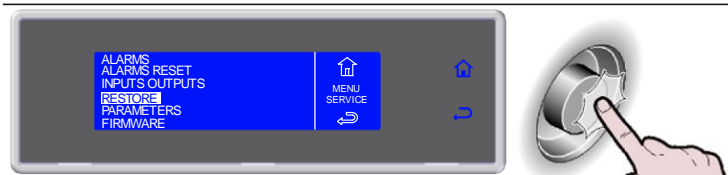

7. Enter the password by turning the knob and press to confirm the value and move to the next one until ENTER is selected

Request the password from SERVICE

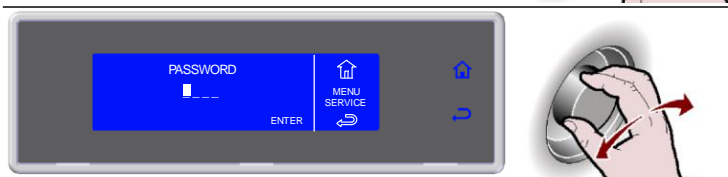

8. Press the knob to confirm and enter section RESTORE

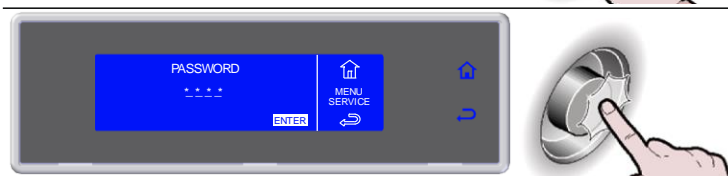

PARAMETERS

ATTENTION: in case of use of this function as a user, contact the manufacturer.

1. Select MENU by rotating the knob



2. Press the knob to enter section MENU

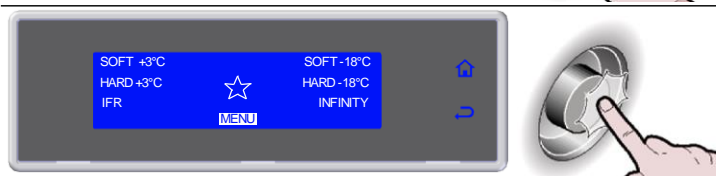

3. Select SERVICE by rotating the knob



4. Press the knob to enter section SERVICE



5. Select PARAMETERS by rotating the knob



6. Press the knob to enter section PARAMETERS



7. Enter the password by turning the knob and press to confirm the value and move to the next one until ENTER is selected

Request the password from SERVICE

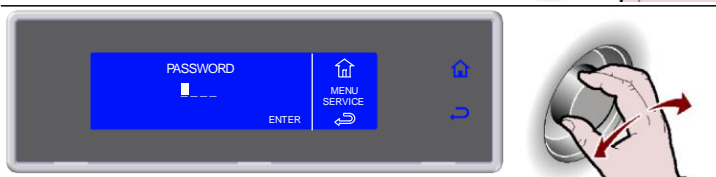

8. Press the knob to confirm and enter section PARAMETERS



MAINTENANCE

MAINTENANCE AND CLEANING

CLEANING THE CABINET

Clean inside the cooling cabinet daily.
Both the cabinet and all the internal components have been designed and shaped to allow washing and cleaning all parts easily.
Before cleaning, defrost the appliance and remove the internal drain.
Disconnect the master switch.
Clean all components (stainless-steel, plastic or painted parts) with lukewarm water and detergent.
Then rinse and dry without using abrasives or chemical solvents.

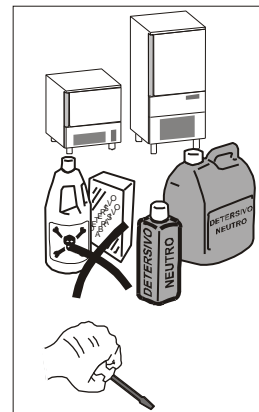

Do not wash the appliance by spraying high-pressure water on the machine.

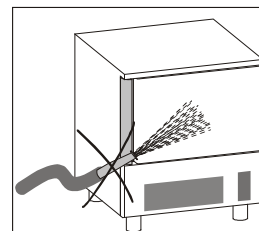

Do not rinse with sharp or abrasive tools, especially the evaporator.

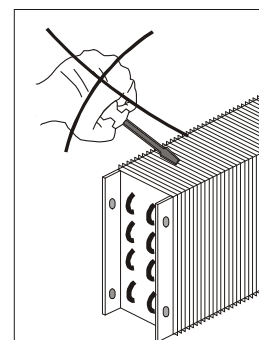

You may clean inside the evaporator after loosening the knobs and rotating the protection component.

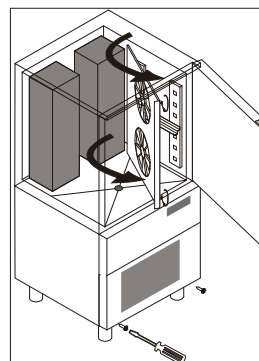

Wash the door gasket with water. Accurately dry with a dry cloth. We recommend wearing protecting gloves throughout the operations.

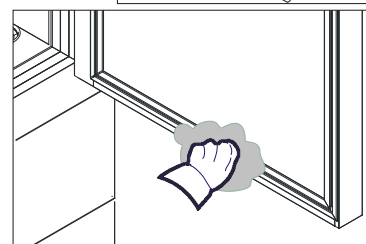

Hand-wash the probe using lukewarm water and a mild detergent or products with biodegradability higher than 90%. Rinse with water and sanitary solution. Do not use detergents containing solvents (such as trichloroethylene, etc) or abrasive powders
ATTENTION: do not use hot water to wash the probe.

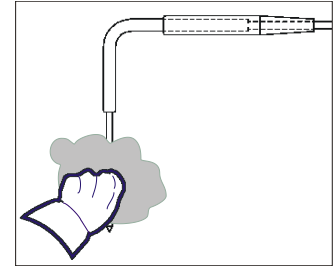

CLEANING THE AIR CONDENSER

The air condenser should be kept clean to ensure the appliance's performance and efficiency, as air should freely circulate inside the appliance.

The condenser should therefore be cleaned every 30 days, using non-metal brushes to remove all dust and dirt from condenser blades.

Access to the condenser is from the front.

Unhook the front guard, pulling it and turning it to the right.



STAINLESS-STEEL MAINTENANCE

By stainless steel we mean INOX AISI 304 steel.
 We recommend following the instructions below for the maintenance and cleaning of stainless-steel parts.
 This is of the utmost importance to ensure the non-toxicity and complete hygiene of the processed foodstuffs.
 Stainless-steel is provided with a thin oxide layer which prevents it from rusting. However, some detergents may destroy or affect this layer, therefore causing corrosion.
 Before using any cleansing product, ask your dealer about a neutral chloriness cleansing product, as to avoid steel corrosions.
 If the surface has been scratched polish it with fine STAINLESS-STEEL wool or a synthetic-fibre abrasive sponge. Always rub in the direction of the silking.
WARNING: Never use iron wool for cleaning STAINLESS STEEL.
 Furthermore, avoid leaving iron wool on the appliance surface as tiny iron deposits may cause the surface to rust by contamination and affect the hygiene of the appliance.

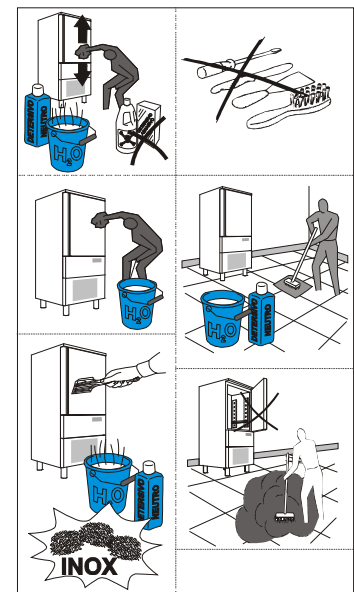

DISCONTINUED USE

Should the machine be disconnected over long periods, follow the instructions below to maintain the appliance in good condition:

Turn the mains switch OFF.

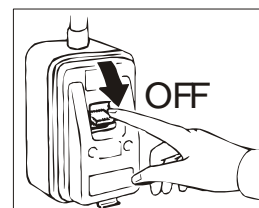

Disconnect the plug.

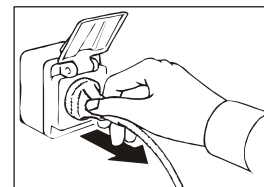

Empty the appliance and clean it in accordance with the instructions given in the chapter "CLEANING".

Leave the door ajar to prevent a bad smell.

Cover the compressor unit with a nylon cloth to protect it from dust.

In case of appliances with remote control, if you decide to turn it off, remember to put the switch off also in the remote control..

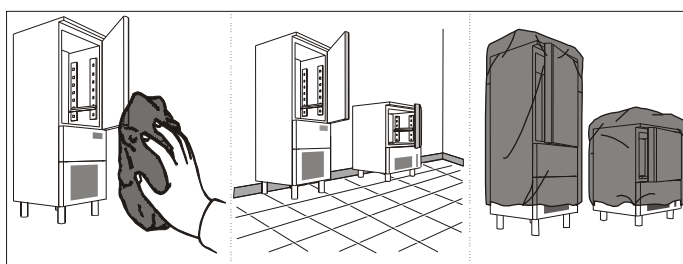

EXTRAORDINARY MAINTENANCE

The information and instructions in this section are reserved for specialised personnel, authorised to operate on the equipment components.

VIDEO BOARD AND ENCODER MAINTENANCE CHECKLIST

Turn the mains switch OFF.

Disconnect the plug.

To access the video board and the encoder:

Mod. 10Kg

Undo the two screws securing the plane.
Rotate the plane and unplugging the power cord of the video board.



Undo the screws and remove the cover to access to the video card and to the encoder.



Mod. 20Kg

Undo the screw under the dashboard.
Unhook the dashboard, pulling it forward.



Undo the guard screws and remove the cover to access the encoder.

Mod. 72Kg

Undo the screw under the dashboard.
Turn the dashboard upwards.

Undo the guard screws and remove the cover to access to the video card and to the encoder.

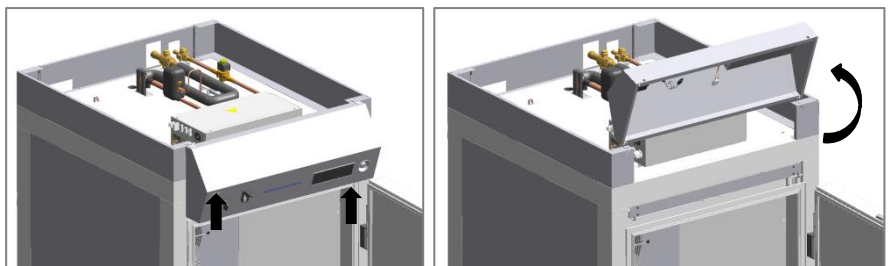

Mod. 144Kg

Undo the screw under the dashboard.
Unhook the dashboard, pulling it and turning it to the left.

Undo the guard screws and remove the cover to access to the video card and to the encoder.

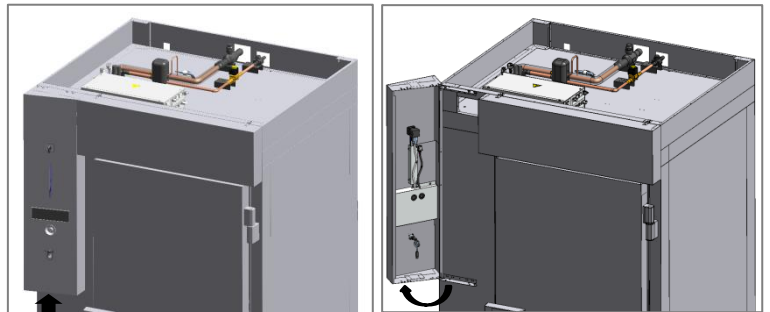

MAINTENANCE OF PANEL BOARD

Turn the mains switch OFF.
Disconnect the plug.

To be able to access the electric picture:

Mod. 10Kg

Unhook the front guard, pulling it and turning it to the right.



Remove the closing panel screws.
Remove the closing panel.

Remove the electrical panel locking screw.
Move the electrical panel box along the slide.



Mod. 20Kg

Unhook the front guard, pulling it and turning it to the right.

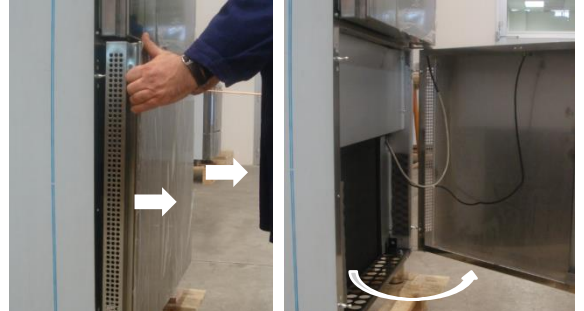

Remove the closing panel screws.
Remove the closing panel.



Remove the electrical panel locking screw.
Move the electrical panel box along the slide.

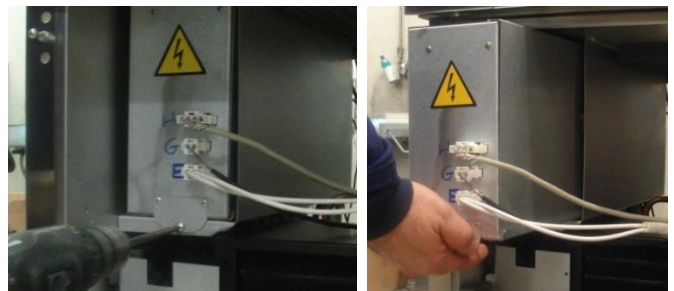

Mod. 72Kg – 144Kg

Remove the electrical board cover with a tool to access the internal components from above.

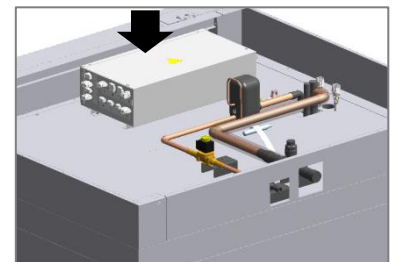

UPDATING THE FIRMWARE (SOFTWARE) OF THE ELECTRONIC CIRCUIT BOARDS

Check the firmware versions of the unit's circuit boards.

1. Select MENU by rotating the knob

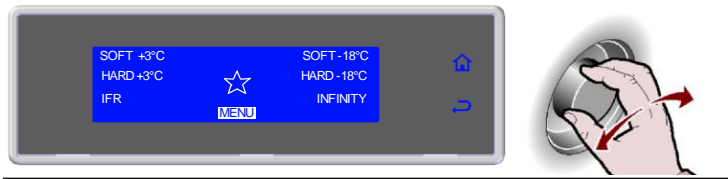

2. Press the knob to enter section MENU



3. Select SERVICE by rotating the knob



4. Press the knob to enter section SERVICE



5. Select FIRMWARE by rotating the knob



6. Press the knob to view the FIRMWARE



7. Check the firmware versions of the unit's circuit boards



UPDATE PROCEDURE

The procedure should only be performed by specialist personnel.

WARNING: this function only resets the original parameters, keeping the customised cycles, HACCP data and alarms already memorised.

A PC or similar system running Microsoft Windows is required in order to update the circuit boards' firmware (software).

WARNING: The display adapter's microprocessor does not manage the USB port directly.

An RS232/USB converter cable is required to install the RS232/USB (*accessory list - KSAW*) data conversion driver on your PC.



For the procedure, refer to the “**Guide for updating the circuit board firmware**” included in the enclosures with the product on the website www.sagispa.it, in the CD attached to the KASW or contacting **SERVICE**.

CONDENSING SYSTEM MAINTENANCE

To access the condensing system, remove the rear protective grille, undoing the screws.



REPLACEMENT CORE PROBE

Turn left completely unscrewing the connector to disconnect the cable of the core probe.

Replace the core probe by screwing the connector fully.



ENERGY CONSUMPTION CHART

	IF51M	IF101L	IF101S	IFR201R	IFR202R IFP202R
Chilled full load capacity [kg]	22	45	45	120	210
Cooling temperature [°C]	+65 ÷ +10				
Time cycle (chilling) [min]	120				
Energy consumption for chilling [kWh/kg]	0,084	0,126	0,126	0,107	0,110
Frozen full load capacity [kg]	13	27	27	72	144
Freezing temperature [°C]	+65 ÷ -18				
Time cycle (freezing) [min]	270				
Energy consumption for freezing [kWh/kg]	0,301	0,398	0,398	0,362	0,319
Refrigerant name	R452A				
GWP	2141				
Refrigerant charge [kg]	1,4	2	2	5	10

WIRING DIAGRAM PLATE

The electrical diagram is shown on the last page of the booklet.

N°	DESCRIPTION	N°	DESCRIPTION
1	COMPRESSOR	72	ELECTRONIC DATA CARD LCD
2	CONDENSER FAN	73	FUSE-HOLDER WITH UNIPOLAR FUSE
2A	THERMOSTATED CONDENSER FAN	75	ELECTROVALVE
3	GENERAL TERMINAL BOARD	76	MAGNETIC MICRO-SWITCH
3A	GENERAL TERMINAL BOARD	77	COMPARTMENT PROBE
3B	GENERAL TERMINAL BOARD	78	EVAP./DEFROST PROBE
9	EVAPORATOR FUN	79A	MULTIPOINT NEEDLE CORE PROBE
20	DOOR ANTICONDENSING RESISTOR	79B	MULTIPOINT PROBE RESISTANCE
21	DEFROST RESISTANCE	80	PTC RESISTANCE FOR COMPRESSOR CASING
21A	DEFROST RESISTANCE	86	CONDENSER PROBE
25	TRANSFORMER	87	LCD QUICK COOLER CARD
56	FILTER	97A	EVAP. FAN CHOKE MODULE
65	CONTACTOR	102	BIMETALLIC SAFETY THERMOSTAT
66	THERMAL RELAY	122	LED LAMPS
67	EVAPORATOR FAN RUN CAPACITOR	127	RGB CONTROLLER
67A	EVAPORATOR FAN RUN CAPACITOR	128	USB ADAPTER
69	GROUNDING TERMINAL	129	ENCODER ADAPTER
70	HIGH PRESSURE PRESSOSTAT		
71	POWER PANEL ELECTRONIC CARD		